

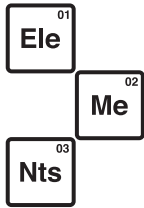

SIXINCH[®] x POPULOUS[®]



LOBBY FEATURING MULTIPLE COMPOUNDS



Elements

Inspired by the Periodic Table, Elements is a modular seating and work solution designed for multiple configurations. Elements creates a fun representation of versatility in usage. Perfect for any environment.

Like chemistry, unique compounds are formed with the combination of Elements.

Highlights

Elements offers four key features:

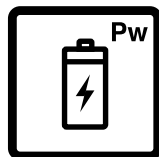

Power

Qi and USB
Power integration

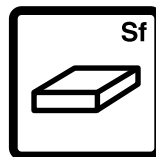

Surface

Durable Solid Surface
Tops for All Tables

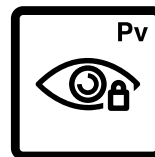

Privacy

Screening Options
for Visual Separation

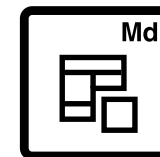

Modularity

Create the Optimal
Arrangement

General Information



Materials

Seating Structure:
Foam wrapped, upholstered wood frame
Wood base with glides

Table Structure:
Solid surface table top
Powder coated metal base

Screen Structure:
Upholstered screen
Powder coated metal base

Options

Seating:
Quilted blanket accent

Table:
Byrne Electric Qi and USB charger

Ganging, Tethering:
Yes

Environment

Suitable for any indoor environment



Graded-In Fabric Partners

Anzea	Gabriel	Momentum
Camira	KB Contract	Pallas Textiles
Carnegie	Maharam	Ultrafabrics
C.F. Stinson	Mayer	Unika Vaev
EnviroLeather		

visit sixinchusa.com/graded-in-fabrics for more information

visit sixinchusa.com/video-library to see more

Color / Finish

Solid Surface Table Top



Black



White



Grey



Light Grey



Sand

Table Legs & Base / Divider Legs & Base



Black
RAL 9004



White
RAL 9016



Copper
RAL 8029

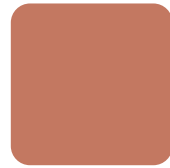

Blush
RAL 3012



Honey
RAL 1034



Seafoam
RAL 6019



Pigeon Blue
RAL 5014



Signal Grey
RAL 7004

Quilting Patterns

Blanket Option Patterns



Cinch



Diamond



Diamond 2



Diamond Wave



Hourglass

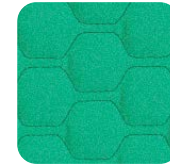

Hex

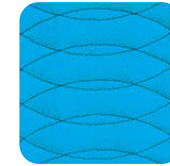

Wave



Circle



Channel



Diamond Point

Dimensions

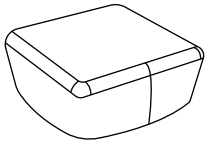

Ottoman

W 37.0 x **D** 37.0 x **H** 15.0
SH 15.0
WT 30.0lbs

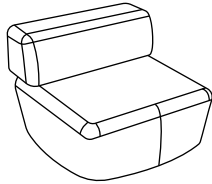

Standard Seat

W 37.0 x **D** 37.0 x **H** 28.0
SD 24.0 x **SH** 15.0
WT 57.0lbs

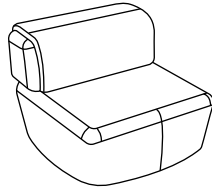

Standard Seat w/Blanket

W 37.0 x **D** 37.0 x **H** 28.0
SD 24.0 x **SH** 15.0
WT 57.0lbs

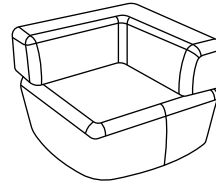

Corner

W 37.0 x **D** 37.0 x **H** 28.0
SD 24.0 x **SH** 15.0
WT 69.0lbs

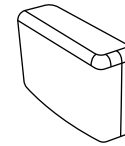

Arm

W 13.0 x **D** 37.0 x **H** 25.0
WT 35.0lbs

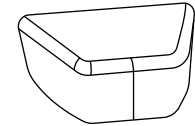

45 Corner

W 44.0 x **D** 37.0 x **H** 15.0
SH 15.0
WT 30.0lbs

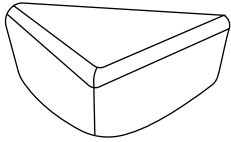

90 Corner

W 47.0 x **D** 27.5 x **H** 15.0
SH 15.0
WT 25.0lbs

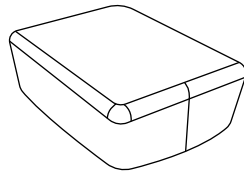

Chaise Ottoman

W 37.0 x **D** 51.0 x **H** 15.0
SH 15.0
WT 37.0lbs

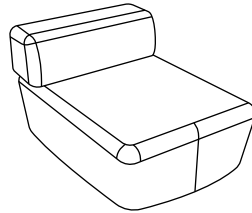

Chaise

W 37.0 x **D** 51.0 x **H** 28.0
SD 37.0 x **SH** 15.0
WT 60.0lbs

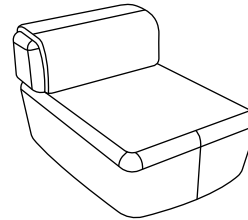

Chaise w/Blanket

W 37.0 x **D** 51.0 x **H** 28.0
SD 37.0 x **SH** 15.0
WT 60.0lbs

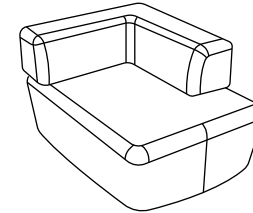

Chaise Corner Left

W 37.0 x **D** 51.0 x **H** 28.0
SD 37.0 x **SH** 15.0
WT 81.0lbs

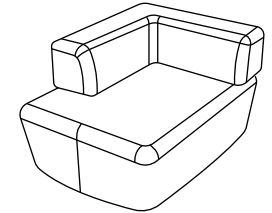

Chaise Corner Right

W 37.0 x **D** 51.0 x **H** 28.0
SD 37.0 x **SH** 15.0
WT 81.0lbs

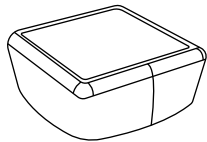

Ottoman Table

W 37.0 x **D** 37.0 x **H** 15.0
SH 15.0
WT 60.0lbs

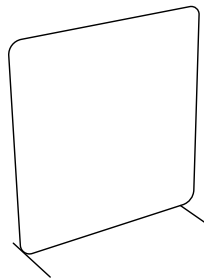

Divider

W 37.0 x **H** 42.5
WT 20.0lbs

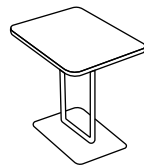

Side Table

W 24.0 x **D** 18.0 x **H** 19.75
WT 53.0lbs

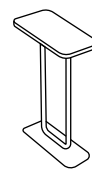

Pull-Up Table

W 18.0 x **D** 9.0 x **H** 21.75
WT 20.0lbs

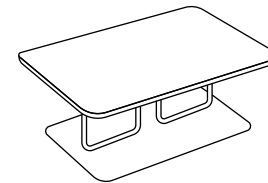

Coffee Table

W 41.5.0 x **D** 29.5 x **H** 15.5
WT 155lbs

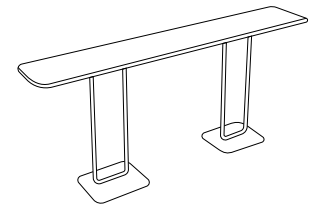

Sofa (Tall) Table

W 72.0 x **D** 12.0 x **H** 30.0
WT 105.0lbs



📷 All images shown can be found online
at [sixinchusa.com](https://www.sixinchusa.com)



Ottoman



Standard Seat



Standard Seat w/Blanket



Corner



Arm



45 Corner



90 Corner



Chaise Ottoman

 All images shown can be found online at [sixinchusa.com](https://www.sixinchusa.com)



Chaise



Chaise w/Blanket



Chaise Corner (Left or Right)



Ottoman Table



Divider



Side Table



Pull-Up Table



Coffee Table



Tall Table

 All images shown can be found online at [sixinchusa.com](https://www.sixinchusa.com)

Fabric Zoning

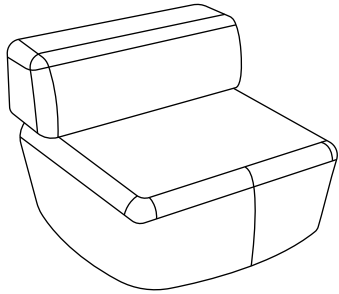

Solid

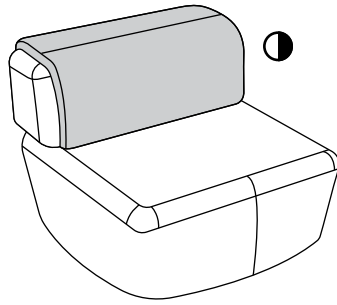

Solid + Blanket (C)

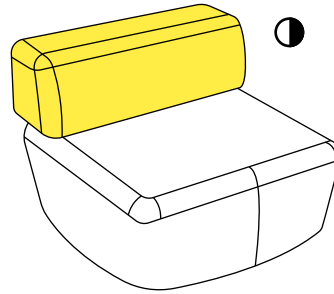

Seat (A) + Back (B)

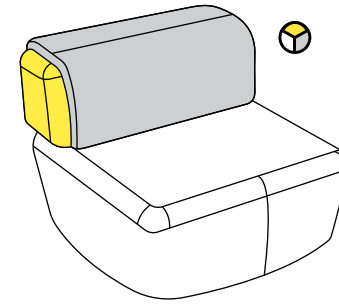

Seat (A) + Back (B) + Blanket (C)

Power Option



Byrne HQ™

ByrneHQ™ is a place where all of your technology can come together to recharge however you connect. There's USB access for your tablet, power for your laptop, even wireless – simply set any Qi-friendly device on the surface, and you're charging.

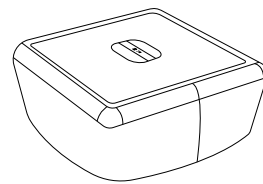
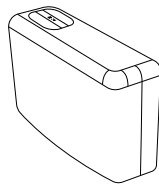
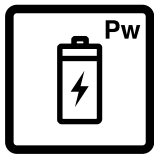

Power may be added to the Arm, Cushion Table or Tall Table.

Quilted Blanket Accent

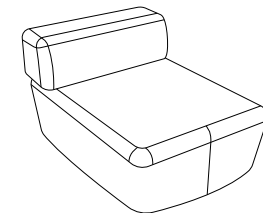
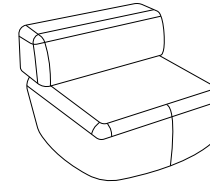
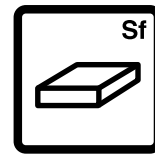

The quilted blanket can only be ordered with a standard or chase unit. Hidden snaps allow the blanket to be added at a later date should you choose.



📷 All images shown can be found online
at [sixinchusa.com](https://www.sixinchusa.com)



📷 All images shown can be found online
at [sixinchusa.com](https://www.sixinchusa.com)

Compound Configuration Examples

Element's key feature is the ability to create a modular seating arrangement that suits any indoor environment. Form your Compound utilizing seating, tables and power integration. Sample configurations are shown, proving just how versatile Elements can be.

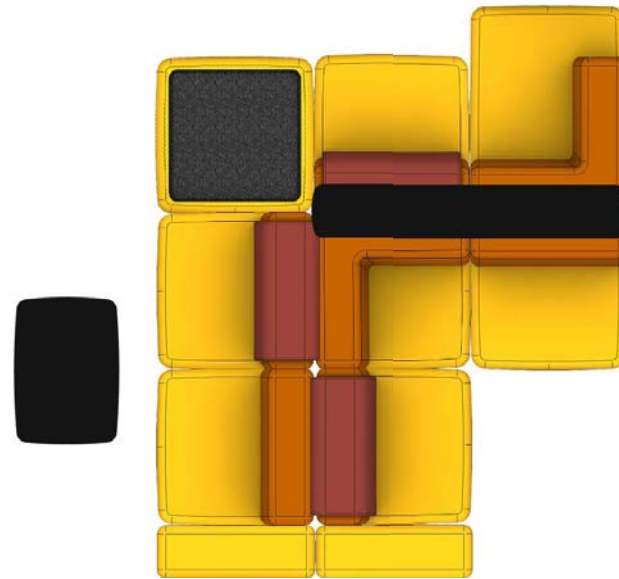
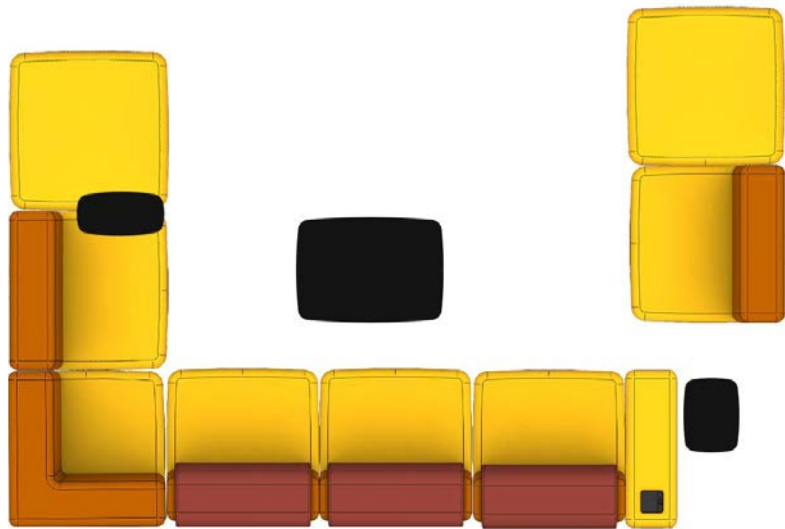
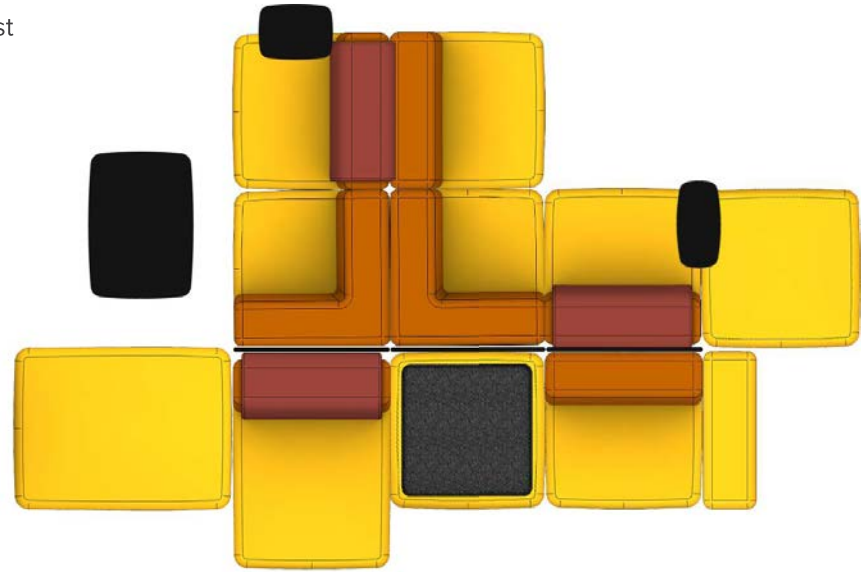
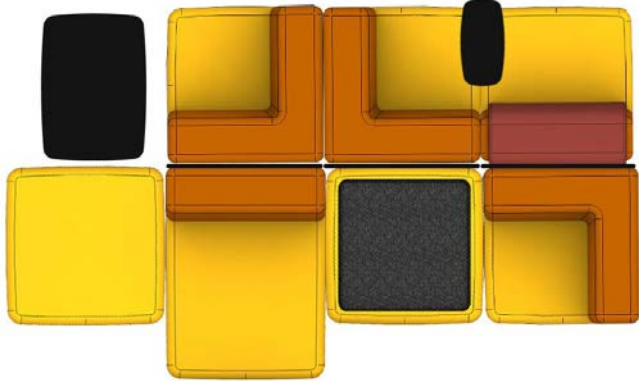

Compound Configuration Examples

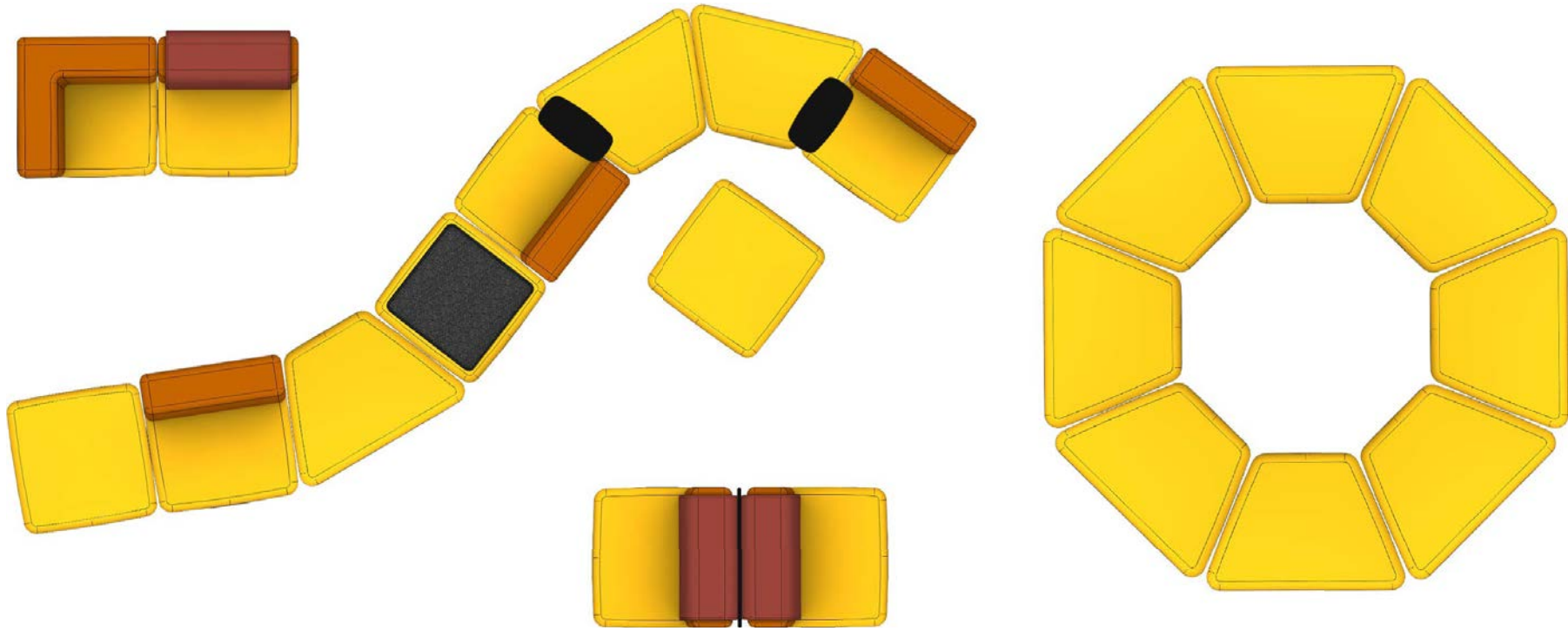

Service / Warranty

Servicing

Damaged components in need of replacement require an image of the damaged part and a reference to your order number. Please email this information to **support@sixinch.us** and we will be happy to provide replacement options.

* Visit **sixinchusa.com/warranty** for details on service and warranty terms and conditions.

Quote

Online

Visit **sixinchusa.com**, create an account and submit your quote. A customer service representative will be in touch to guide you through the purchasing process or put you in touch with your regional rep.

Upholstery Warranty

SIXINCH warrants that upholstery applications shall be free from defects in materials and workmanship for a period of five (5) years from the date of purchase. Softening of foam will occur through normal use and is not a manufacturing defect.



Phone / Email

Call **855-577-2417** or email **support@sixinch.us**. Your regional rep contact information can also be found at **sixinchusa.com/connect**.

Brand Promise

We offer our customers endless creativity, backed by generations of industry experience. We deliver through quality, creativity and flexibility. We're here to help you create, entertain and work (a little). For more information visit **sixinchusa.com** or call us at **855-577-2417**.



SIXINCH® North America
901 East Madison Street, Goshen, IN 46528
855-577-2417
support@sixinch.us