

 sixinch®

@SIXINCHUSA



WE'VE TAKEN
25% OFF
 **FLEXPLUS**
LIST
PRICING

PRICE LIST

2024 

ACTIVE **JUNE 22ND, 2024**
ALL OTHER PRICE LISTS ARE VOID

THE BRAND



About

Founded in Belgium in 2003. SIXINCH was born from a passion for innovative materials and progressive design. In 2013, SIXINCH Belgium partnered with Wieland Designs, a well-respected company in the furniture industry, and expanded the footprint for one of the most talked about furniture brands in the world. The name SIXINCH comes from the space between our ears, a mere 150mm wide, or six inches.



Our Mission

We build iconic environments that are distinctly original. Our team of designers and engineers are detailed to a fault. We have the ability to not only “dream” but also “do”. Every piece that bears the SIXINCH label is held to the highest standards in the furniture industry.



Our Brand Promise

We offer our customers endless creativity, backed by generations of industry experience. We deliver through quality, creativity and flexibility. We’re here to help you create, entertain and enjoy work.



Custom

The design flexibility of SIXINCH coated foam is almost limitless, and that’s exactly why this technique is perfect for custom projects. There are no molding or set up costs. We start from a large foam bun which is CNC cut into the desired shape. Our FlexPlus™ coating is applied and the entire color spectrum is at your disposal. When completed, your product is a flexible, weather-resistant, seamless design statement.



Shown Above: Cliffy 6000, Splatter Pig

Fabric is in our DNA.

With more than 30 years in the industry, we know what it takes to do upholstery right. We challenge you to find a better upholsterer in the industry. Our thread artisans go through extensive training, and by the time they graduate, they're ready to hand deliver a top notch product.

Pick from our standard offering of textiles or choose your own. No matter what route you decide to go, your client is bound to be ecstatic!

TABLE OF CONTENTS

Guest		Poufs		Benches		Tables		Accessories	
Basic	08	Animals	36	Arrow	35	ALMG Table	51	Ganging	81
Link	15	Bench 1	29	Bench	29	Bubble Topper	74	Cush'n	24
Louis 1 Arm	44	Block 1	22	Block 2	22	Boz	78	Elevate Planter	72
Louis 1 Armless	44	Bubble	18	Cliffy 360	46	Elements	65	Sprout Hanger	80
Louis 1b Arm	44	Diamond Pouf 1,2	27	Cliffy Pouf	47	Elevate Work	67	Tethering	81
Nuke	07	Eggy	17	Cubik Bench	50	Elevate Lounge	69	Weights	81
Scoop	13	Fidget	56	Diamond Pouf 3	27	Juke (Outdoor)	07		
Tauko	09	H Pouf	22	Letters	30	Lily	78		
		Hex Arrow	25	Roblock	26	LVL Topper	55		
Lounge		Hex Pouf	24	Rock Element	43	Mimmo Collection	75		
ALMG	51	Peanut	56	Sattel Bank	16	Plain Collection	77	Colors & Patterns	
Bench Sofa 1	40	Puzzle	22	Sattel Wagen	16	Tauko Collection	74	FlexPlus™	82
Circle Lounge	48	Roblock 1	26	Split	71	Twiggy	78	Molded PE	
Cliffy 1000	47	Sattel	16	Steen Table	27			Laminate/HPL	
Cubik	49	Steen Pouf	27	Twist Bench 1	28	Acoustic / Screens		Thermoform	
Diamond Seat 0,1	39	Tapa Pouf	56	Twist Bench 2	28	Bothy	73	Powder Coat	
Glo	53	Tapa Sq Pouf	58	Twist Braid	28	CIO	79	PET Felt	
Gnarly	52	Trinity 4	40			Echo	80	Quilting Patterns	
Louis II Armchair	43	Twist Pouf 1	28	Modular Lounge		Elements	67		
Lounge S	48	Twist Pouf 2	28	Beast	45	Forest	80	General Information	
Rocky Chair	17	Wrapz	17	Elements	62	Staxx	79	Upholstery	88
Rocky Plush	17			Elevate	66	TC	79	Technical Data	
S1 0,1	38			Island	59			Maintenance	
S1 Elephant 1	39	Sofas		LVL (Levels)	54	Outdoor (Not FlexPlus)		Terms & Conditions	
Scoop Lounge	13	Bench Sofa 2	40	Tapa	56	Barstool	14		
Sole	52	Cliffy 2k,4k, 6k	47	Tapa Square	58	Elevate	66		
Tubular	51	Cubik Settee	49	Trinity	41	Juke Table	07		
Twist Lounge	28	Cubik Sofa	49	Trinity Jr.	42	Nuke	07		
		Diamond Seat 2,3	40			Rocky Chair	17		
Ottomans		Louis II Loveseat	44	Stools		Trinity Outdoor	41		
Axis	14	Louis III Sofa	44	Barstool	14				
Cubik Ottoman	49	River Must Flow	48	Link Barstool	15				
Gnarly Ottoman	53	S1 2,3,4	38	Louis Barstool	43				
Sattel	16	S1 Elephant 2,4	39	Scoop Barstool	14				
Trinity 3	41	Steen Sofa	27	Tauko	10				
Trinity 3 Jr.	42								
Twist Ottoman	28								



Shown Above: Gnarly low-back, Custom Wrapz, Custom in-wall seating

LIVV ARM

Designed by DAVID FOX

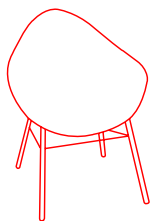

DISCONTINUED
LIMITED INVENTORY
PLEASE CALL

LIVV ARMLESS

Designed by DAVID FOX

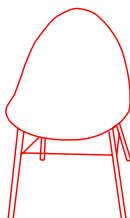

DISCONTINUED
LIMITED INVENTORY
PLEASE CALL

TINGLE

Designed by Jason Bird

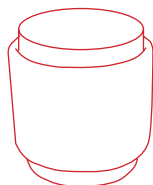

Model: Tingle 1
Weight: Approx 20 lbs.
Base: Rotational Molded PE
Cushion: Foam
Cushion Finish: Upholstered
Quick Ship: Call

Dimensions:
DIA: 16
SH: 16.5

DISCONTINUED

Nuke Seat Pad	Yardage	COM	A	B	C	D	E	F	G	H	I
Tingle 1 UPH Cushion	1	\$700	\$733	\$750	\$773	\$797	\$820	\$853	\$887	\$949	\$1,002
Tingle 2 UPH Cushion	1	\$750	\$783	\$800	\$823	\$847	\$870	\$903	\$937	\$999	\$1,052

BLOCKY

Designed by SIXINCH® Design

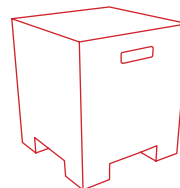

Model: Blocky
Weight: Approx 20 lbs.
Base: Rotational Molded PE
Standard Finish: White
Light: No
Quick Ship: Call

Dimensions: **List Price \$450**
W: 16.5
D: 16.5
H: 18.5
SH: 18.5

DISCONTINUED

BLOCKY 2 - LED LIGHT

Designed by SIXINCH® Design

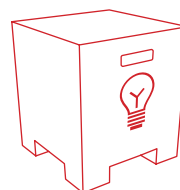

Model: Blocky 2 Light
Weight: Approx 20 lbs.
Base: Rotational Molded PE
Standard Finish: White ONLY
Light: Yes

Dimensions: **List Price \$600**
W: 16.5
D: 16.5
H: 18.5
SH: 18.5

DISCONTINUED



Designed by Brado

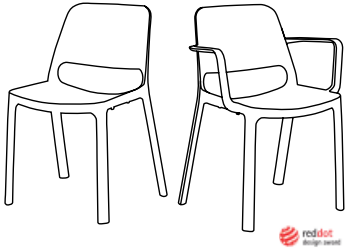

Model: Nuke
Weight: Approx 10 lbs.
Chair: Polypropylene
Stocked Colors: Snowball, Roccia
Imported Colors: Powder, Oceano, Ice Surf, Swamp, Sandy, Sun Splash, Coral Bay, Lava
Stacking: Armless - Yes (6)

Dimensions:
 W: 24
 D: 20
 H: 32
 SH: 18

Purchased in sets of (4)
Armless List Price \$350
Armed List Price \$375

Purchased individually
Armless List Price \$390
Armed List Price \$415

**Per Chair Price*

100% Recycled: Roccia, Oceano, Lava



Nuke Seat Pad	Yardage	COM	A	B	C	D	E	F	G	H	I
Armless (set of 4)	0.75	\$370	\$395	\$407	\$425	\$442	\$460	\$485	\$510	\$557	\$597
Armed (set of 4)	0.75	\$410	\$435	\$447	\$465	\$482	\$500	\$525	\$550	\$597	\$637



Designed by Nowy Styl

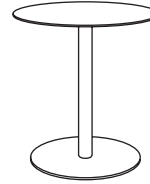

Model: Juke Outdoor Table
Weight: Approx
Table Material: Resin
Top Finish: White, Grey, Black
Table Options: Round, Square, Rounded Square
Table Thickness: 1"
Table Size: 30"
Base: Metal
Base Finish: Grey

Dimensions:
 DIA: 30
 H: 29
List Price \$1,139

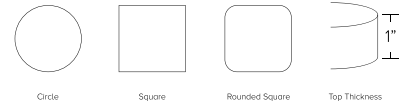

Note: Base imported, Tops made in USA



BASIC

Designed by Stiwood



Model: Basic 4 Leg
Base: Metal
Base Finish: Chrome
Shell: Beech Wood
Shell Finish: Beech (Clear)
 Fully Upholstered (Quilted)
 FlexPlus™ Coated
Stacking: Yes (6)
**inventoried, please call.*

Dimensions:
 W: 17.5
 D: 20
 H: 36
 SH: 18.5
 SD: 17

List Price \$390



Model: Basic 4 Leg Open Arms
Base: Metal
Base Finish: Chrome
Arm Finish: Chrome
 w/Plastic Armrest
Shell: Beech Wood
Shell Finish: Beech (Clear)
 Fully Upholstered (Quilted)
 FlexPlus™ Coated
Stacking: Yes (6)
**inventoried, please call.*

Dimensions:
 W: 17.5
 D: 20
 H: 36
 SH: 18.5
 SD: 17

List Price \$450



Model: Basic 4 Leg Closed Arms
Base: Metal
Base Finish: Chrome
Arm Finish: Chrome
 w/Plastic Armrest
Shell: Beech Wood
Shell Finish: Beech (Clear)
 Fully Upholstered (Quilted)
 FlexPlus™ Coated
Stacking: Yes (6)
**minimum order quantity, please call.*

Dimensions:
 W: 17.5
 D: 20
 H: 36
 SH: 18.5
 SD: 17

List Price \$619



Model: Basic Sled
Base: Metal
Base Finish: Chrome
Shell: Beech Wood
Shell Finish: Beech (Clear)
 Fully Upholstered (Quilted)
 FlexPlus™ Coated
Stacking: Yes (6)
**minimum order quantity, please call.*

Dimensions:
 W: 17.5
 D: 20
 H: 36
 SH: 18.5
 SD: 17

List Price \$559

FLEXPLUS™ COATED SHELL



+ \$500
 TO LIST PRICE



Fully Quilted / List Pricing

Basic	Yardage	COM	A	B	C	D	E	F	G	H	I
4 Leg Wood	1.25	\$625	\$667	\$687	\$717	\$746	\$775	\$817	\$858	\$936	\$1,003
Sled	1.25	\$808	\$850	\$870	\$900	\$929	\$958	\$1,000	\$1,041	\$1,119	\$1,186
4 Leg Metal	1.25	\$453	\$495	\$515	\$545	\$574	\$603	\$645	\$686	\$764	\$831
4 Leg Metal / Open Arm	1.25	\$600	\$642	\$662	\$692	\$721	\$750	\$792	\$833	\$911	\$978
4 Leg Metal / Loop Arm	1.25	\$904	\$946	\$966	\$996	\$1,025	\$1,054	\$1,096	\$1,137	\$1,215	\$1,282

Estimated Weight

Basic has an estimated weight range of 10-15 lbs.

* Weight is based on base type and options.



Import / 12-14 Week Lead Time



Inventoried / Color and options limited
 Lead time varies 10-15 days - call for details

TAUKO GUEST

Import / 12-14 Week Lead Time

Designed by Mac Stopa



Model: Tauko Guest - Sled
Base: Metal
Base Finish: Black
Shell: Formed Beech Wood
Shell Finish: Beech (Clear)
 Stained Wood
 Veneer Wood
Stacking: Yes
 Wood Shell - (8)
 Wood w/Seat Pad (6)

Dimensions:
 W: 23.5
 D: 22
 H: 32
 SH: 17.5
 SD: 18

List Pricing: \$650

Clear Beech Shell
 Black Wire Base

Upgrades

[Add to List Price](#)

Shell:

+\$134 Veneer
+\$50 Stained Wood
 (Slightly Visible Grain)

Legs:

+\$38 Chrome
+\$35 Hard Floor Glides

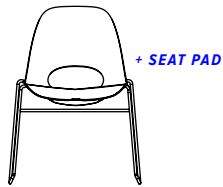

Model: Tauko Guest - Sled
Base: Metal
Base Finish: Black
Shell: Formed Beech Wood
Shell Finish: Beech (Clear)
 Stained Wood
 Veneer Wood
Stacking: Yes
 Wood Shell - (8)
 Wood w/Seat Pad (6)

Dimensions:
 W: 23.5
 D: 22
 H: 32
 SH: 17.5
 SD: 18

List Pricing: \$1,122

Era +\$194

Valencia +\$194

Blazer/Synergy +\$248

Clear Beech Shell
 Black Wire Base

Upgrades

[Add to List Price](#)

Shell:

+\$134 Veneer
+\$50 Stained Wood
 (Slightly Visible Grain)

Legs:

+\$38 Chrome
+\$35 Hard Floor Glides

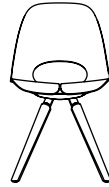

Model: Tauko Guest - Wood
Base: Wood
Base Finish: Clear, Stained
Shell: Formed Beech Wood
Shell Finish: Beech (Clear)
 Stained Wood
 Veneer Wood
Stacking: No

Dimensions:
 W: 18
 D: 22
 H: 32
 SH: 17.5
 SD: 18

List Pricing: \$1,457

Clear Beech Shell
 Clear Beech Wood Base

Upgrades

[Add to List Price](#)

Shell:

+\$134 Veneer
+\$50 Stained Wood
 (Slightly Visible Grain)

Legs:

+\$50 Stained Wood
 (Slightly Visible Grain)
+\$35 Hard Floor Glides

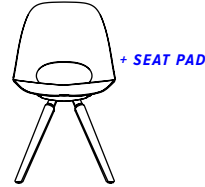

Model: Tauko Guest - Wood
Base: Wood
Base Finish: Clear, Stained
Shell: Formed Beech Wood
Shell Finish: Beech (Clear)
 Stained Wood
 Veneer Wood
Stacking: No

Dimensions:
 W: 18
 D: 22
 H: 32
 SH: 17.5
 SD: 18

List Pricing: \$1,457

Era +\$194

Valencia +\$194

Blazer/Synergy +\$248

Clear Beech Shell
 Clear Beech Wood Base

Upgrades

[Add to List Price](#)

Shell:

+\$134 Veneer
+\$50 Stained Wood
 (Slightly Visible Grain)

Legs:

+\$50 Stained Wood
 (Slightly Visible Grain)
+\$35 Hard Floor Glides

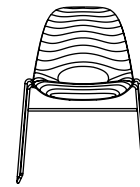

Model: Tauko Guest - Sled
Base: Metal
Base Finish: Black
Shell: Formed Beech Wood
Shell Finish: Fully Uph
Stacking: Yes
 Fully Uph (6)

Dimensions:
 W: 23.5
 D: 22
 H: 32
 SH: 17.5
 SD: 18

List Pricing: \$1,122

Era +\$409

Valencia +\$409

Blazer/Synergy +\$493

Clear Beech Shell
 Black Base

Upgrades

[Add to List Price](#)

Legs:

+\$38 Chrome
+\$35 Hard Floor Glides



Model: Tauko Guest - Wood
Base: Wood
Base Finish: Clear, Stained
Shell: Formed Beech Wood
Shell Finish: Fully Uph
Stacking: No

Dimensions:
 W: 18
 D: 22
 H: 32
 SH: 17.5
 SD: 18

List Pricing: \$1,457

Era +\$409

Valencia +\$409

Blazer/Synergy +\$493

Clear Beech Shell
 Clear Beech Wood Base

Upgrades

[Add to List Price](#)

Legs:

+\$50 Stained Wood
 (Slightly Visible Grain)
+\$35 Hard Floor Glides

Estimated Weight

The Tauko chairs have a weight range of 16-18 lbs.
 The Tauko Stools have a weight range of 22-24 lbs.

* Weight is based on base type and options.

TAUKO COUNTER



Import / 12-14 Week Lead Time

Designed by Mac Stopa

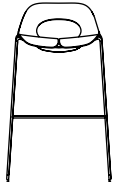

Model: Tauko LB Counter - Sled
Base: Metal
Base Finish: Black
Shell: Formed Beech Wood
Shell Finish: Beech (Clear)
 Stained Wood
 Veneer Wood
Stacking: No

Dimensions:
 W: 22.5
 D: 22.5
 H: 33
 SH: 26
 SD: 18

List Pricing: \$1,227
 Clear Beech Shell
 Black Wire Base

Upgrades
Add to List Price
Shell:
 +\$111 Veneer
 +\$42 Stained Wood (Slightly Visible Grain)
Legs:
 +\$50 Chrome
 +\$35 Hard Floor Glides

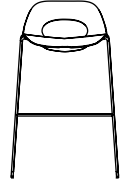

+ SEAT PAD

Model: Tauko LB Counter - Sled
Base: Metal
Base Finish: Black
Shell: Formed Beech Wood
Shell Finish: Beech (Clear)
 Stained Wood
 Veneer Wood
Stacking: No

Dimensions:
 W: 22.5
 D: 22.5
 H: 33
 SH: 26
 SD: 18

List Pricing: \$1,227
Era +\$194
Valencia +\$194
Blazer/Synergy +\$248

Clear Beech Shell
 Black Wire Base
Upgrades
Add to List Price
Shell:
 +\$111 Veneer
 +\$42 Stained Wood (Slightly Visible Grain)
Legs:
 +\$58 Stained Wood (Slightly Visible Grain)
 +\$35 Hard Floor Glides

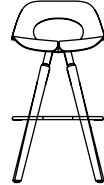

Model: Tauko LB Counter - Wood
Base: Wood
Base Finish: Clear, Stained
Shell: Formed Beech Wood
Shell Finish: Beech (Clear)
Stacking: No

Dimensions:
 W: 18.5
 D: 20
 H: 33
 SH: 26
 SD: 18

List Pricing: \$1,581
 Clear Beech Shell
 Clear Beech Wood Base

Upgrades
Add to List Price
Shell:
 +\$111 Veneer
 +\$42 Stained Wood (Slightly Visible Grain)
Legs:
 +\$58 Stained Wood (Slightly Visible Grain)
 +\$35 Hard Floor Glides

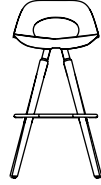

+ SEAT PAD

Model: Tauko LB Counter - Wood
Base: Wood
Base Finish: Clear, Stained
Shell: Formed Beech Wood
Shell Finish: Beech (Clear)
Stacking: No

Dimensions:
 W: 18.5
 D: 20
 H: 33
 SH: 26
 SD: 18

List Pricing: \$1,581
Era +\$194
Valencia +\$194
Blazer/Synergy +\$248

Clear Beech Shell
 Clear Beech Wood Base
Upgrades
Add to List Price
Shell:
 +\$111 Veneer
 +\$42 Stained Wood (Slightly Visible Grain)
Legs:
 +\$58 Stained Wood (Slightly Visible Grain)
 +\$35 Hard Floor Glides

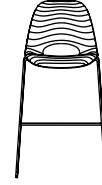

Model: Tauko HB Counter - Sled
Base: Metal
Base Finish: Black
Shell: Formed Beech Wood
Shell Finish: Fully Uph
Stacking: No

Dimensions:
 W: 22.5
 D: 22.5
 H: 40
 SH: 26
 SD: 18

List Pricing: \$1,227
Era +\$409
Valencia +\$409
Blazer/Synergy +\$493

Clear Beech Shell
 Black Wire Base

Upgrades
Add to List Price
Legs:
 +\$50 Chrome
 +\$35 Hard Floor Glides



Model: Tauko HB Counter - Wood
Base: Wood
Base Finish: Clear, Stained
Shell: Formed Beech Wood
Shell Finish: Fully Uph
Stacking: No

Dimensions:
 W: 22.5
 D: 22.5
 H: 40
 SH: 26
 SD: 18

List Pricing: \$1,581
Era +\$409
Valencia +\$409
Blazer/Synergy +\$493

Clear Beech Shell
 Clear Beech Wood Base

Upgrades
Add to List Price
Legs:
 +\$58 Stained Wood (Slightly Visible Grain)
 +\$35 Hard Floor Glides

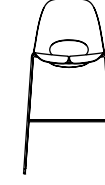

Model: Tauko HB Counter - Sled
Base: Metal
Base Finish: Black
Shell: Formed Beech Wood
Shell Finish: Beech (Clear)
 Stained Wood
 Veneer Wood
Stacking: No

Dimensions:
 W: 22.5
 D: 22.5
 H: 40
 SH: 26
 SD: 18

List Pricing: \$1,227
 Clear Beech Shell
 Black Wire Base

Upgrades
Add to List Price
Shell:
 +\$111 Veneer
 +\$50 Stained Wood (Slightly Visible Grain)
Legs:
 +\$50 Chrome
 +\$35 Hard Floor Glides

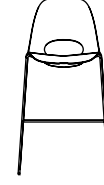

+ SEAT PAD

Model: Tauko HB Counter - Sled
Base: Metal
Base Finish: Black
Shell: Formed Beech Wood
Shell Finish: Beech (Clear)
 Stained Wood
 Veneer Wood
Stacking: No

Dimensions:
 W: 22.5
 D: 22.5
 H: 40
 SH: 26
 SD: 18

List Pricing: \$1,227
Era +\$194
Valencia +\$194
Blazer/Synergy +\$248

Clear Beech Shell
 Black Wire Base
Upgrades
Add to List Price
Shell:
 +\$111 Veneer
 +\$50 Stained Wood (Slightly Visible Grain)
Legs:
 +\$50 Chrome
 +\$35 Hard Floor Glides

Estimated Weight

The Tauko chairs have a weight range of 16-18 lbs.
 The Tauko Stools have a weight range of 22-24 lbs.

* Weight is based on base type and options.

TAUKO COUNTER



Import / 12-14 Week Lead Time

Designed by Mac Stopa

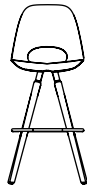
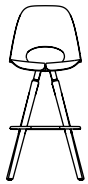

+ SEAT PAD

Model: Tauko HB Counter - Wood
Base: Wood
Base Finish: Clear, Stained
Shell: Formed Beech Wood
Shell Finish: Beech (Clear)
 Stained Wood
 Veneer Wood
Stacking: No

Dimensions:

W: 22.5
 D: 22.5
 H: 40
 SH: 26
 SD: 18

List Pricing: \$1,581

Clear Beech Shell
 Clear Beech Wood Base

Upgrades

Add to List Price

Shell:
 +\$111 Veneer
 +\$50 Stained Wood
 (Slightly Visible Grain)

Legs:
 +\$58 Stained Wood
 (Slightly Visible Grain)
 +\$35 Hard Floor Glides

Model: Tauko HB Counter - Wood
Base: Wood
Base Finish: Clear, Stained
Shell: Formed Beech Wood
Shell Finish: Beech (Clear)
 Stained Wood
 Veneer Wood
Stacking: No

Dimensions:

W: 22.5
 D: 22.5
 H: 40
 SH: 26
 SD: 18

List Pricing: \$1,581

Era +\$194
Valencia +\$194
Blazer/Synergy +\$248

Clear Beech Shell
 Clear Beech Wood Base

Upgrades

Add to List Price

Shell:
 +\$111 Veneer
 +\$50 Stained Wood
 (Slightly Visible Grain)

Legs:
 +\$58 Stained Wood
 (Slightly Visible Grain)
 +\$35 Hard Floor Glides

TAUKO BAR



Import / 12-14 Week Lead Time

Designed by Mac Stopa

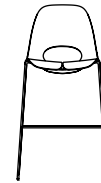

+ SEAT PAD



+ SEAT PAD

Model: Tauko HB Bar - Sled
Base: Metal
Base Finish: Black
Shell: Formed Beech Wood
Shell Finish: Beech (Clear)
 Stained Wood
 Veneer Wood
Stacking: No

Dimensions:

W: 22.5
 D: 22.5
 H: 44
 SH: 30
 SD: 18

List Pricing: \$1,227

Clear Beech Shell
 Black Wire Base

Upgrades

Add to List Price

Shell:
 +\$111 Veneer
 +\$50 Stained Wood
 (Slightly Visible Grain)

Legs:
 +\$35 Chrome
 +\$35 Hard Floor Glides

Model: Tauko HB Bar - Sled
Base: Metal
Base Finish: Black
Shell: Formed Beech Wood
Shell Finish: Beech (Clear)
 Stained Wood
 Veneer Wood
Stacking: No

Dimensions:

W: 22.5
 D: 22.5
 H: 44
 SH: 30
 SD: 18

List Pricing: \$1,227

Era +\$194
Valencia +\$194
Blazer/Synergy +\$248

Clear Beech Shell
 Black Wire Base

Upgrades

Add to List Price

Shell:
 +\$111 Veneer
 +\$50 Stained Wood
 (Slightly Visible Grain)

Legs:
 +\$50 Chrome
 +\$35 Hard Floor Glides

Model: Tauko HB Bar - Wood
Base: Wood
Base Finish: Clear, Stained
Shell: Formed Beech Wood
Shell Finish: Beech (Clear)
 Stained Wood
 Veneer Wood
Stacking: No

Dimensions:

W: 22.5
 D: 22.5
 H: 44
 SH: 30
 SD: 18

List Pricing: \$1,581

Clear Beech Shell
 Clear Beech Wood Base

Upgrades

Add to List Price

Shell:
 +\$111 Veneer
 +\$50 Stained Wood
 (Slightly Visible Grain)

Legs:
 +\$58 Stained Wood
 (Slightly Visible Grain)
 +\$35 Hard Floor Glides

Model: Tauko HB Bar - Wood
Base: Wood
Base Finish: Clear, Stained
Shell: Formed Beech Wood
Shell Finish: Beech (Clear)
 Stained Wood
 Veneer Wood
Stacking: No

Dimensions:

W: 22.5
 D: 22.5
 H: 44
 SH: 30
 SD: 18

List Pricing: \$1,581

Era +\$194
Valencia +\$194
Blazer/Synergy +\$248

Clear Beech Shell
 Clear Beech Wood Base

Upgrades

Add to List Price

Shell:
 +\$111 Veneer
 +\$50 Stained Wood
 (Slightly Visible Grain)

Legs:
 +\$58 Stained Wood
 (Slightly Visible Grain)
 +\$35 Hard Floor Glides

Estimated Weight

The Tauko Stools have a weight range of 22-24 lbs.

* Weight is based on base type and options.



Import / 12-14 Week Lead Time



Inventoried / Color and options limited
 Lead time varies 10-15 days - call for details

TAUKO BAR



Import / 12-14 Week Lead Time

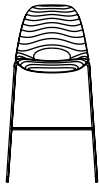

Model: Tauko HB Bar - Sled
Base: Metal
Base Finish: Black
Shell: Formed Beech Wood
Shell Finish: Fully Uph
Stacking: No

Dimensions:

W: 22.5
D: 22.5
H: 44
SH: 30
SD: 18

List Pricing: \$1,227

Era +\$409

Valencia +\$409

Blazer/Synergy +\$493

Clear Beech Shell
Black Wire Base

Upgrades

Add to List Price

Legs:
+\$50 Chrome
+\$35 Hard Floor Glides



Model: Tauko HB Bar - Wood
Base: Wood
Base Finish: Clear, Stained
Shell: Formed Beech Wood
Shell Finish: Fully Uph
Stacking: No

Dimensions:

W: 22.5
D: 22.5
H: 44
SH: 30
SD: 18

List Pricing: \$1,581

Era +\$409

Valencia +\$409

Blazer/Synergy +\$493

Clear Beech Shell
Clear Beech Wood Base

Upgrades

Add to List Price

Legs:
+\$58 Stained Wood
(Slightly Visible Grain)
+\$35 Hard Floor Glides

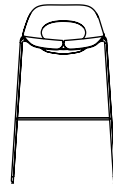

Model: Tauko LB Bar - Sled
Base: Metal
Base Finish: Black
Shell: Formed Beech Wood
Shell Finish: Beech (Clear)
Stained Wood
Veneer Wood
Stacking: No

Dimensions:

W: 22.5
D: 22.5
H: 36.5
SH: 30
SD: 18

List Pricing: \$1,227

Clear Beech Shell
Black Wire Base

Upgrades

Add to List Price

Shell:
+\$111 Veneer
+\$42 Stained Wood
(Slightly Visible Grain)

Legs:
+\$50 Chrome
+\$35 Hard Floor Glides

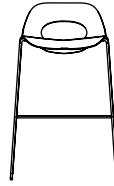

+ SEAT PAD

Model: Tauko LB Bar - Sled
Base: Metal
Base Finish: Black
Shell: Formed Beech Wood
Shell Finish: Beech (Clear)
Stained Wood
Veneer Wood
Stacking: No

Dimensions:

W: 22.5
D: 22.5
H: 36.5
SH: 30
SD: 18

List Pricing: \$1,227

Era +\$194

Valencia +\$194

Blazer/Synergy +\$248

Clear Beech Shell
Black Wire Base

Upgrades

Add to List Price

Shell:
+\$111 Veneer
+\$42 Stained Wood
(Slightly Visible Grain)

Legs:
+\$50 Chrome
+\$35 Hard Floor Glides

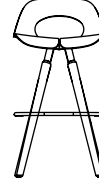

Model: Tauko LB Bar - Wood
Base: Wood
Base Finish: Clear, Stained
Shell: Formed Beech Wood
Shell Finish: Beech (Clear)
Stacking: No

Dimensions:

W: 18.5
D: 20
H: 36.5
SH: 30
SD: 18

List Pricing: \$1,581

Clear Beech Shell
Clear Beech Wood Base

Upgrades

Add to List Price

Shell:
+\$111 Veneer
+\$42 Stained Wood
(Slightly Visible Grain)

Legs:
+\$58 Stained Wood
(Slightly Visible Grain)
+\$35 Hard Floor Glides

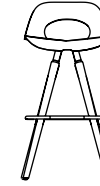

+ SEAT PAD

Model: Tauko LB Bar - Wood
Base: Wood
Base Finish: Clear, Stained
Shell: Formed Beech Wood
Shell Finish: Beech (Clear)
Stacking: No

Dimensions:

W: 18.5
D: 20
H: 36.5
SH: 30
SD: 18

List Pricing: \$1,581

Era +\$194

Valencia +\$194

Blazer/Synergy +\$248

Clear Beech Shell
Clear Beech Wood Base

Upgrades

Add to List Price

Shell:
+\$111 Veneer
+\$42 Stained Wood
(Slightly Visible Grain)

Legs:
+\$58 Stained Wood
(Slightly Visible Grain)
+\$35 Hard Floor Glides



Import / 12-14 Week Lead Time



Inventoried / Color and options limited
Lead time varies 10-15 days - call for details

SCOOP

Designed by Stiwood



Model: Scoop Sled
Base: Metal
Base Finish: Chrome
Shell: Formed Wood
Shell Finish: Fully Uph

**minimum order quantity, please call.*

Dimensions:

W: 21
 D: 22
 H: 32
 SH: 17
 SD: 17



Model: Scoop 4 Star
Base: Metal
Base Finish: Chrome
Shell: Formed Wood
Shell Finish: Fully Uph

**minimum order quantity, please call.*

Dimensions:

W: 21
 D: 22
 H: 32
 SH: 17
 SD: 17

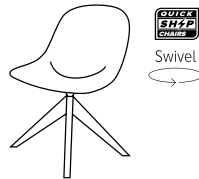

Model: Scoop Pyramidal
Base: Wood
Species: Ash
Base Finish: Bleached, Walnut
Shell: Formed Wood
Shell Finish: Fully Uph

**Inventoried, please call.*

Dimensions:

W: 21
 D: 22
 H: 32
 SH: 17
 SD: 17

Scoop	Yardage	COM	A	B	C	D	E	F	G	H	I
Metal 4 Star	1.5	\$1,055	\$1,105	\$1,130	\$1,165	\$1,200	\$1,235	\$1,285	\$1,335	\$1,428	\$1,508
Sled	1.5	\$893	\$943	\$968	\$1,003	\$1,038	\$1,073	\$1,123	\$1,173	\$1,266	\$1,346
Wood Pyramidal	1.5	\$1,238	\$1,288	\$1,313	\$1,348	\$1,383	\$1,418	\$1,468	\$1,518	\$1,611	\$1,691

Estimated Weight

The Scoop chairs have a weight range 16-20 lbs.
 The Scoop Lounge have a weight range of 30 -40 lbs.

** Weight is based on base type and options.*

SCOOP LOUNGE

Designed by Stiwood

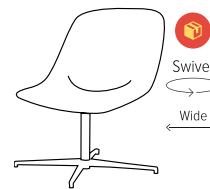

Model: Scoop Lounge 4 Star
Base: Metal
Base Finish: Chrome
Shell: Formed Wood
Shell Finish: Fully Uph

**minimum order quantity, please call.*

Dimensions:

W: 27
 D: 28
 H: 33
 SH: 17.5
 SD: 17.5

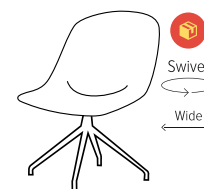

Model: Scoop Lounge Pyramidal
Base: Metal
Base Finish: Chrome
Shell: Formed Wood
Shell Finish: Fully Uph

**minimum order quantity, please call.*

Dimensions:

W: 27
 D: 28
 H: 33
 SH: 17.5
 SD: 17.5

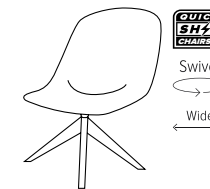

Model: Scoop Lounge Pyramidal
Base: Wood
Species: Ash
Base Finish: Bleached, Walnut
Shell: Formed Wood
Shell Finish: Fully Uph

**Inventoried, please call.*

Dimensions:

W: 27
 D: 28
 H: 33
 SH: 17.5
 SD: 17.5

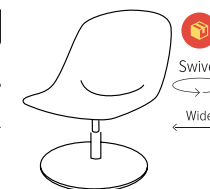

Model: Scoop Lounge Pedestal
Base: Metal
Base Finish: Chrome
Shell: Formed Wood
Shell Finish: Fully Uph

**minimum order quantity, please call.*

Dimensions:

W: 27
 D: 28
 H: 33
 SH: 17.5
 SD: 17.5

Scoop Lounge	Yardage	COM	A	B	C	D	E	F	G	H	I
4 Star Metal	1.5	\$1,221	\$1,271	\$1,296	\$1,331	\$1,366	\$1,401	\$1,451	\$1,501	\$1,594	\$1,674
Metal Pyramidal	2	\$1,320	\$1,387	\$1,420	\$1,467	\$1,513	\$1,560	\$1,627	\$1,693	\$1,818	\$1,924
Wood Pyramidal	2	\$1,335	\$1,402	\$1,435	\$1,482	\$1,522	\$1,575	\$1,642	\$1,708	\$1,833	\$1,939
LIDO Pedestal	2	\$1,509	\$1,576	\$1,609	\$1,656	\$1,702	\$1,749	\$1,816	\$1,882	\$2,007	\$2,113

Import / 12-14 Week Lead Time

Inventoried / Color and options limited
 Lead time varies 10-15 days - call for details

- List prices for FlexPlus™ coated products includes standard colors.
- Custom FlexPlus coating colors add \$500 net price per color match. Requires customer match approval.
- Upholstered products offered for graded-in fabric selections.

- All list prices are FOB: Factory Goshen, IN USA
- All product dimensions are shown in INCHES
- For finish options [SEE PAGE 82](#)

SIXINCH™ USA / 901 East Madison / Goshen, IN 46528 USA / (855) 577-2417 / support@sixinch.us / sixinchusa.com

REMINDER: Void if printed. Remember to double-check pricing from current price list on SIXINCH website
<https://sixinchusa.com/price-list>

SCOOP STOOL



Designed by Brado



Model: Scoop Stool Sled
Base: Metal
Base Finish: Chrome
Shell: Formed Wood
Shell Finish: Fully Uph
**minimum order quantity, please call.*

Dimensions:
W: 16.5
D: 19.5
H: 39
SH: 31
SD: 14

Scoop Stool	Yardage	COM	A	B	C	D	E	F	G	H	I
Metal Sled	1.5	\$759	\$809	\$834	\$869	\$904	\$939	\$989	\$1,039	\$1,132	\$1,212

BARSTOOL

Designed by SIXINCH® Design

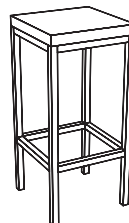

Model: Barstool
Base: Metal
Base Finish: Powder Coat
Seat Pad: FlexPlus™ Coated or Upholstered

Dimensions:
W: 14
D: 14
H: 31
SH: 31

Barstool	Yardage	COM	A	B	C	D	E	F	G	H	I
	1	\$850	\$883	\$900	\$923	\$947	\$970	\$1,003	\$1,037	\$1,099	\$1,152

AXIS

Designed by SIXINCH® USA

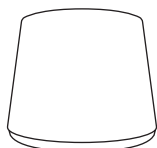

Model: Axis
Weight: Approx 65 lbs.
Base: Exposed Maple Wood
Base Finish: Clear
Shell: Wood (X frame wrapped)
Shell Finish: Upholstered

Dimensions:
W: 23
D: 23
H: 20
SH: 20
SD: 16

Axis	Yardage	COM	A	B	C	D	E	F	G	H	I
Solid (1)	2	\$1,500	\$1,567	\$1,600	\$1,647	\$1,693	\$1,740	\$1,807	\$1,873	\$1,998	\$2,104
Two-Tone (2/3)	2.5	\$1,500	\$1,583	\$1,625	\$1,683	\$1,742	\$1,800	\$1,883	\$1,967	\$2,122	\$2,255

*If the textiles used in multi-zoning are different grades, use price of the higher grade level.

Option 1

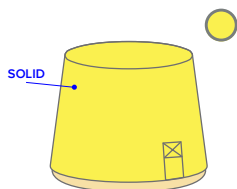

Option 2

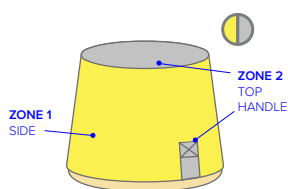

Option 3

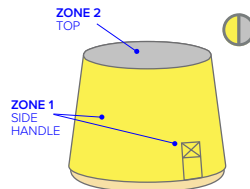

LINK

Designed by Alba



Model: Link 4 Leg Metal
Base: Metal
Base Finish: Chrome
Shell: Molded Plastic
Shell Color: Moss, Lemon, Black, Oyster
Seat Pad: Yes
Stack: Yes (4)
**Inventoried, please call.*

Dimensions:
W: 18.5
D: 18.5
H: 30.5
SH: 18
SD: 15

List Price \$300



Model: Link Sled
Base: Metal
Base Finish: Chrome
Shell: Molded Plastic
Shell Color: Moss, Lemon, Black, Oyster
Seat Pad: Yes
Stack: Yes (4)
**Inventoried, please call.*

Dimensions:
W: 18.5
D: 18.5
H: 30.5
SH: 18
SD: 15

List Price \$433



Model: Link 4 Star
Base: Metal
Base Finish: Chrome
Shell: Molded Plastic
Shell Color: Moss, Lemon, Black, Oyster
Seat Pad: Yes
Stack: No
**minimum order quantity, please call.*

Dimensions:
W: 18.5
D: 18.5
H: 30.5
SH: 18
SD: 15

List Price \$448



Model: Link 4 Leg Wood
Base: Wood
Base Finish: Clear
Shell: Molded Plastic
Shell Color: Moss, Lemon, Black, Oyster
Seat Pad: Yes
Stack: No
**Inventoried, please call.*

Dimensions:
W: 18.5
D: 18.5
H: 30.5
SH: 18
SD: 15

List Price \$330



Model: Link 5 Star Caster
Base: Metal
Base Finish: Chrome
Shell: Molded Plastic
Shell Color: Moss, Lemon, Black, Oyster
Seat Pad: Yes
Stack: No
**minimum order quantity, please call.*

Dimensions:
W: 24
D: 24
H: 30.5
SH: 18
SD: 15

List Price \$486

LINK STOOL

Designed by Alba



Model: Link Bar Stool
Base: Metal
Base Finish: Chrome
Shell: Molded Plastic
Shell Color: Moss, Lemon, Black, Oyster
Seat Pad: Yes
Stack: Yes (4)
**minimum order quantity, please call.*

Dimensions:
W: 22.5
D: 22.5
H: 44
SH: 30
SD: 18

List Price \$523

Link Seat Pad	Yardage	COM	A	B	C	D	E	F	G	H	I
4 Leg Metal	0.75	\$350	\$375	\$387	\$405	\$422	\$440	\$465	\$490	\$537	\$577
Sled Metal	0.75	\$485	\$510	\$522	\$540	\$555	\$575	\$600	\$625	\$672	\$712
4 Star Metal	0.75	\$501	\$526	\$538	\$556	\$573	\$591	\$616	\$641	\$688	\$728
4 Leg Wood w/ Plastic	0.75	\$350	\$375	\$387	\$405	\$422	\$440	\$465	\$490	\$537	\$577
5 Star Caster	0.75	\$539	\$564	\$576	\$594	\$611	\$629	\$654	\$679	\$726	\$766

Barstool - Sled	0.75	\$575	\$600	\$612	\$630	\$645	\$665	\$690	\$715	\$762	\$802
-----------------	------	-------	-------	-------	-------	-------	-------	-------	-------	-------	-------

Estimated Weight
The Link chairs have a weight range of 15-20 lbs.
The Link Stool have a weight range of 22-24 lbs.

* Weight is based on base type and options.

Import / 12-14 Week Lead Time

Inventoried / Color and options limited
Lead time varies 10-15 days - call for details

- List prices for FlexPlus™ coated products includes standard colors.
- Custom FlexPlus coating colors add \$500 net price per color match. Requires customer match approval.
- Upholstered products offered for graded-in fabric selections.

- All list prices are FOB: Factory Goshen, IN USA
- All product dimensions are shown in INCHES
- For finish options [SEE PAGE 82](#)

SIXINCH™ USA / 901 East Madison / Goshen, IN 46528 USA / (855) 577-2417 / support@sixinch.us / sixinchusa.com

REMINDER: Void if printed. Remember to double-check pricing from current price list on SIXINCH website <https://sixinchusa.com/price-list>

SATTEL WRAPZ

Designed by Common Object

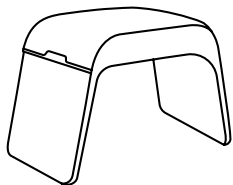

Model: Sattel
Weight: Approx 12 lbs
Shell: Formed Wood
Foam: Fabricated Foam
Zoning: Solid, Two-tone, Three-tone

Dimensions:
W: 26
D: 16
H: 18
SH: 18
SD: 16

Upgrades

[Add to List Price](#)

+\$400 Quilting (Seat/Sides)

Fabric Required:

Solid ly
Two-Tone: Fabric 1 (Seat/Underside) ly Fabric 2 (Handle) ly
Two-Tone: Fabric 1 (Seat) ly Fabric 2 (Underside/Handle) ly
Three-Tone: Fabric 1 (Seat) ly Fabric 2 (Underside) ly Fabric 3 (Handle) ly

Sattel - Upholstered Solid	Yardage	COM	A	B	C	D	E	F	G	H	I
Stool	2	\$873	\$940	\$973	\$1,020	\$1,066	\$1,113	\$1,180	\$1,246	\$1,371	\$1,477

SATTEL BANK

Designed by Common Object

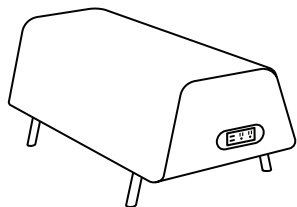

Model: Sattel Bank
Weight: Approx 50 lbs
Shell: Upholstered Wood
Legs: Powder Coated Metal
Casters: Yes
Zoning: Solid, Two-tone

Dimensions:
W: 48
D: 22.5
H: 18
SH: 18
SD: 22.5

BYRNE

Power Option:
 Salt®
 Pepper®

Fabric Required:

Solid ly
Two-Tone: Fabric 1 (Shell) ly Fabric 2 (Seat) ly

Sattel - Upholstered Solid	Yardage	COM	A	B	C	D	E	F	G	H	I
Legs or Casters	2.5	\$1,831	\$1,914	\$1,956	\$2,014	\$2,073	\$2,131	\$2,214	\$2,298	\$2,453	\$2,586
Legs or Casters + 1 power	2.5	\$3,710	\$3,793	\$3,835	\$3,893	\$3,952	\$4,010	\$4,093	\$4,177	\$4,332	\$4,465
Legs or Casters + 2 power	2.5	\$5,806	\$5,889	\$5,931	\$5,989	\$6,048	\$6,106	\$6,189	\$6,273	\$6,428	\$6,561

SATTEL WAGON

Designed by Common Object

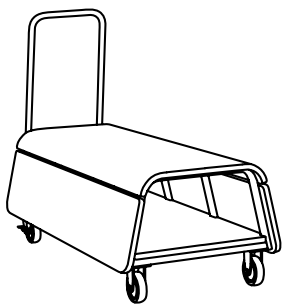

Model: Sattel Wagon
Weight: Approx 75 lbs
Shell/Seat: Tri-plastic
Frame: Metal
Finish Metal: Powder Coated
Finish Tri-Plastic: 3 STD Colors
 Putty, Dark Sage, Grey
Casters: (2) locking, (2) Swivel

Dimensions:
W: 48
D: 22.5
H: 38
SH: 18
SD: 22.5

List Price \$4,200

SATTEL ZONING

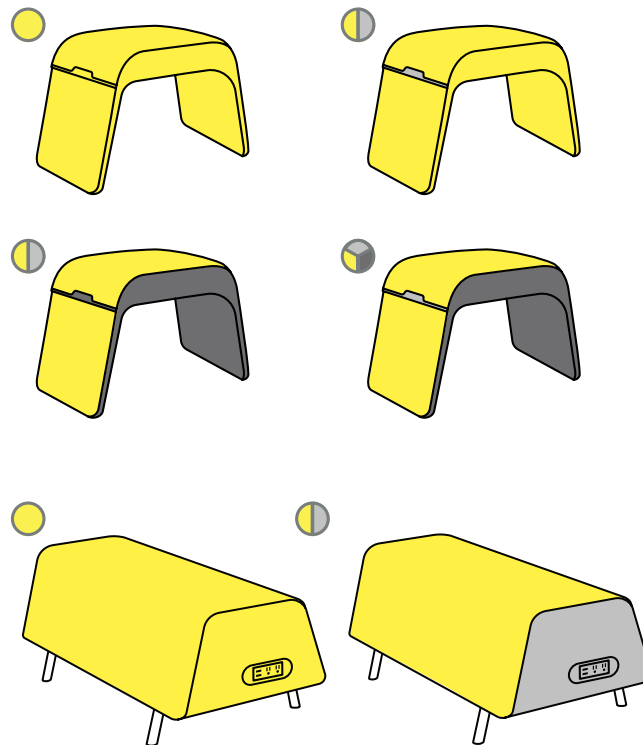

SOLID

Two-Tone

FABRIC 1
 ZONE 1 - SEAT / UNDERSIDE
FABRIC 2
 ZONE 2 - HANDLE

Two-Tone

FABRIC 1
 ZONE 1 - SEAT
FABRIC 2
 ZONE 2 - UNDERSIDE / HANDLE

Three-Tone

FABRIC 1
 ZONE 1 - SEAT
FABRIC 2
 ZONE 2 - UNDERSIDE
FABRIC 3
 ZONE 2 - HANDLE

SOLID

Two-Tone

FABRIC 1
 ZONE 1 - SEAT
FABRIC 2
 ZONE 2 - SIDES

WRAPZ



Designed by SIXINCH® USA

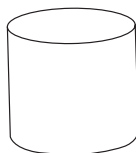

Model: Wrapz Bubble
Weight: Approx 20 lbs.
Base: Uph Zipper or Uph Wood Base w/ Nylon Glides
Material: UV Printed Vinyl or Black Knit
Designs: Standard or Custom

Dimensions:
 DIA: 18
 H: 18
 SH: 18

List Price \$900



Model: Wrapz Cushion
Weight: Approx 9 lbs.
Base: Uph Zipper
Material: UV Printed Vinyl or Black Knit
Designs: Standard or Custom

Dimensions:
 DIA: 16
 H: 6

List Price \$550

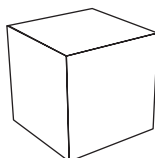

Model: Wrapz Block 1
Weight: Approx 25 lbs.
Base: Uph Zipper or Uph Wood Base w/ Nylon Glides
Material: UV Printed Vinyl or Black Knit
Designs: Standard or Custom

Dimensions:
 W: 18
 D: 18
 SH: 18

List Price \$900

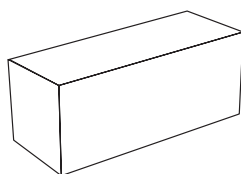

Model: Wrapz Block 2
Weight: Approx 30 lbs.
Base: Uph Zipper or Uph Wood Base w/ Nylon Glides
Material: UV Printed Vinyl or Black Knit
Designs: Standard or Custom

Dimensions:
 W: 36
 D: 18
 SH: 18

List Pricing: \$1,500

ROCKY CHAIR



Designed by Rainer Mutsch

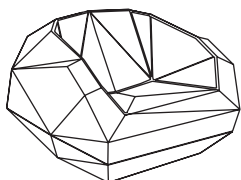

Model: Rocky Chair
Weight: Approx 35 lbs.
Base: Rotational Molded PE
Standard Finish: White
FlexPlus: Yes
Light: No
Quick Ship: White

Dimensions:
 W: 38.5
 D: 41
 H: 25.5
 SH: 15
 SD: 19

List Price \$800

FlexPlus Coated List Price \$3,100

ROCKY CHAIR 2 - LED LIGHT

Designed by Rainer Mutsch

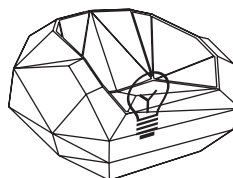

Model: Rocky Chair Light
Weight: Approx 35 lbs.
Base: Rotational Molded PE
Standard Finish: White ONLY
FlexPlus: No
Light: Yes

Dimensions:
 W: 38.5
 D: 41
 H: 25.5
 SH: 15
 SD: 19

List Price \$1,130

ROCKY PLUSH

Designed by SIXINCH® USA

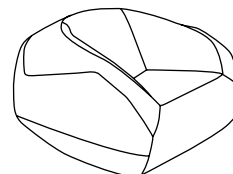

Model: Rocky Plush
Weight: Approx 45 lbs.
Shell: Rotational Molded PE
Finish: Fully Upholstered
Standard Finish: COM
Contrast Stitch: Yes

Dimensions:
 W: 38.5
 D: 41
 H: 15

Rocky Chair Cap	Yardage	COM	A	B	C	D	E	F	G	H	I
Upholstered	4	\$2,414	\$2,547	\$2,614	\$2,707	\$2,801	\$2,894	\$3,027	\$3,161	\$3,409	\$3,623

EGGY

Designed by SIXINCH® USA

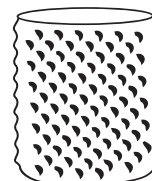

Model: Egg 12
Weight: Approx 15 lbs.
Base: FlexPlus™ Coated Wood
Glides: Plastic (Black)
Material: Foam
Finish: FlexPlus™ Coated

Dimensions:
 W: 19
 D: 19
 H: 12.5
 SH: 16.5

FlexPlus List Price \$1,625

Model: Egg 18
Weight: Approx 20 lbs.
Base: FlexPlus™ Coated Wood
Glides: Plastic (Black)
Material: Foam
Finish: FlexPlus™ Coated

Dimensions:
 W: 19
 D: 19
 H: 18.5
 SH: 16.5

FlexPlus List Price \$2,060



Inventoried / Color and options limited
 Lead time varies 10-15 days - call for details

BUBBLE 1



Designed by SIXINCH® USA



Model: Bubble 16"
Weight: Approx 10 lbs.
 Base UPH: Zipper or Wood w/Plastic Glides
 Base Coated: FlexPlus™ Coated Wood
 Glides: Plastic (Black)
 Metal Leg Finish: Powder Coated
 Material: Foam
 Finish: FlexPlus™ Coated or Upholstered

Dimensions: FlexPlus List Price \$605
 W: 18
 D: 18
 H: 6
 SH: 6

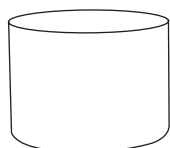

Model: Bubble 12"
Weight: Approx 15 lbs.
 Base UPH: Zipper or Wood w/Plastic Glides
 Base Coated: FlexPlus™ Coated Wood
 Glides: Plastic (Black)
 Metal Leg Finish: Powder Coated
 Material: Foam
 Finish: FlexPlus™ Coated or Upholstered

Dimensions: FlexPlus List Price \$765
 W: 18
 D: 18
 H: 12
 SH: 12
 FlexPlus w/Metal Legs List Price \$900
**Overall Finished Height w/Metal Legs is 12"*

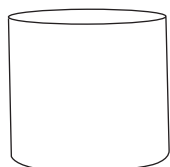

Model: Bubble 18"
Weight: Approx 20 lbs.
 Base UPH: Zipper or Wood w/Plastic Glides
 Base Coated: FlexPlus™ Coated Wood
 Glides: Plastic (Black)
 Metal Leg Finish: Powder Coated
 Material: Foam
 Finish: FlexPlus™ Coated or Upholstered
 Quick Ship: FlexPlus™ Coated

Dimensions: FlexPlus List Price \$945
 W: 18
 D: 18
 H: 18
 SH: 18
 FlexPlus w/Metal Legs List Price \$1,050
**Overall Finished Height w/Metal Legs is 18"*

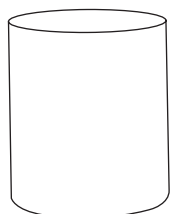

Model: Bubble 24"
Weight: Approx 25 lbs.
 Base UPH: Zipper or Wood w/Plastic Glides
 Base Coated: FlexPlus™ Coated Wood
 Glides: Plastic (Black)
 Material: Foam
 Finish: FlexPlus™ Coated or Upholstered

Dimensions: FlexPlus List Price \$1,115
 W: 18
 D: 18
 H: 24
 SH: 24

* 24" Bubble ottomans can not add metal legs or casters
 * Can not add casters to metal legs

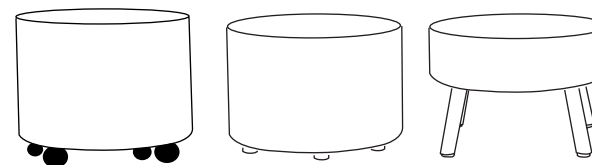

SHOWN: CASTERS / GLIDES / METAL LEGS

Upgrades
 Add to List Price
 +\$225 Casters (add 1.2" to overall height)

Bubble 1	Yardage	COM	A	B	C	D	E	F	G	H	I
Bubble 6" Zipper	1	\$397	\$430	\$447	\$470	\$490	\$517	\$550	\$584	\$646	\$699
Bubble 6" Wood Base/glides	1	\$405	\$438	\$455	\$478	\$498	\$525	\$558	\$592	\$654	\$707
Bubble 12" Zipper	1	\$475	\$508	\$525	\$548	\$568	\$595	\$628	\$662	\$724	\$777
Bubble 12" Wood Base/glides	1	\$485	\$518	\$535	\$558	\$578	\$605	\$638	\$672	\$734	\$787
Bubble 12" Metal legs	1	\$850	\$883	\$900	\$923	\$943	\$970	\$1,003	\$1,037	\$1,099	\$1,152
Bubble 18" Zipper	2	\$586	\$653	\$686	\$733	\$773	\$826	\$893	\$959	\$1,084	\$1,190
Bubble 18" Wood Base/glides	2	\$571	\$638	\$671	\$718	\$758	\$811	\$878	\$944	\$1,069	\$1,175
Bubble 18" Metal legs	2	\$934	\$1,001	\$1,034	\$1,081	\$1,121	\$1,174	\$1,241	\$1,307	\$1,432	\$1,538
Bubble 24" Zipper	2	\$659	\$726	\$759	\$806	\$846	\$899	\$966	\$1,032	\$1,157	\$1,263
Bubble 24" Wood Base/glides	2	\$652	\$719	\$752	\$799	\$839	\$892	\$959	\$1,025	\$1,150	\$1,256

* Can not add casters to metal legs



BUBBLE 2

Designed by SIXINCH® USA

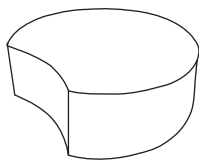

Model: Bubble 2 6"
Weight: Approx 10 lbs.
Base UPH: Zipper or Wood w/Plastic Glides
Base Coated: FlexPlus™ Coated Wood
Glides: Plastic (Black)
Metal Leg Finish: Powder Coated
Material: Foam
Finish: FlexPlus™ Coated or Upholstered

Dimensions: FlexPlus List Price \$605

W: 18
D: 18
H: 6
SH: 6

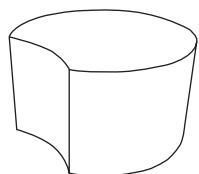

Model: Bubble 2 12"
Weight: Approx 15 lbs.
Base UPH: Zipper or Wood w/Plastic Glides
Base Coated: FlexPlus™ Coated Wood
Glides: Plastic (Black)
Metal Leg Finish: Powder Coated
Material: Foam
Finish: FlexPlus™ Coated or Upholstered

Dimensions: FlexPlus List Price \$765

W: 18
D: 18
H: 12
SH: 12

FlexPlus w/Metal Legs List Price \$900

**Overall Finished Height w/Metal Legs is 12"*

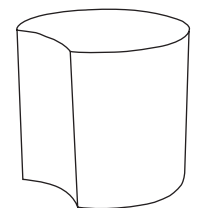

Model: Bubble 2 18"
Weight: Approx 20 lbs.
Base UPH: Zipper or Wood w/Plastic Glides
Base Coated: FlexPlus™ Coated Wood
Glides: Plastic (Black)
Metal Leg Finish: Powder Coated
Material: Foam
Finish: FlexPlus™ Coated or Upholstered

Dimensions: FlexPlus List Price \$945

W: 18
D: 18
H: 18
SH: 18

FlexPlus w/Metal Legs List Price \$1,050

**Overall Finished Height w/Metal Legs is 18"*

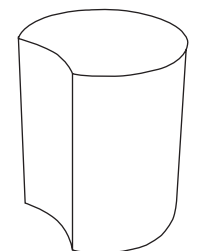

Model: Bubble 2 24"
Weight: Approx 25 lbs.
Base UPH: Zipper or Wood w/Plastic Glides
Base Coated: FlexPlus™ Coated Wood
Glides: Plastic (Black)
Material: Foam
Finish: FlexPlus™ Coated or Upholstered

Dimensions: FlexPlus List Price \$1,115

W: 18
D: 18
H: 24
SH: 24

* 24" Bubble ottomans can not add metal legs or casters
* Can not add casters to metal legs

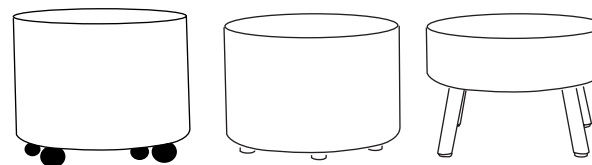

SHOWN: CASTERS / GLIDES / METAL LEGS

Upgrades

[Add to List Price](#)

+\$225 Casters (add 1.2" to overall height)

Bubble 2	Yardage	COM	A	B	C	D	E	F	G	H	I
Bubble 6" Zipper	1	\$397	\$430	\$447	\$470	\$490	\$517	\$550	\$584	\$646	\$699
Bubble 6" Wood Base/glides	1	\$405	\$438	\$455	\$478	\$498	\$525	\$558	\$592	\$654	\$707
Bubble 12" Zipper	1	\$475	\$508	\$525	\$548	\$568	\$595	\$628	\$662	\$724	\$777
Bubble 12" Wood Base/glides	1	\$485	\$518	\$535	\$558	\$578	\$605	\$638	\$672	\$734	\$787
Bubble 12" Metal legs	1	\$850	\$883	\$900	\$923	\$943	\$970	\$1,003	\$1,037	\$1,099	\$1,152
Bubble 18" Zipper	2	\$586	\$653	\$686	\$733	\$773	\$826	\$893	\$959	\$1,084	\$1,190
Bubble 18" Wood Base/glides	2	\$571	\$638	\$671	\$718	\$758	\$811	\$878	\$944	\$1,069	\$1,175
Bubble 18" Metal legs	2	\$934	\$1,001	\$1,034	\$1,081	\$1,121	\$1,174	\$1,241	\$1,307	\$1,432	\$1,538
Bubble 24" Zipper	2	\$659	\$726	\$759	\$806	\$846	\$899	\$966	\$1,032	\$1,157	\$1,263
Bubble 24" Wood Base/glides	2	\$652	\$719	\$752	\$799	\$839	\$892	\$959	\$1,025	\$1,150	\$1,256

* Can not add casters to metal legs

BUBBLE 3

Designed by SIXINCH® USA

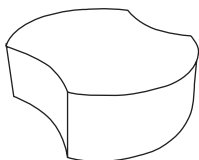

Model: Bubble 3 6"
Weight: Approx 10 lbs.
 Base UPH: Zipper or Wood w/Plastic Glides
 Base Coated: FlexPlus™ Coated Wood
 Glides: Plastic (Black)
 Metal Leg Finish: Powder Coated
 Material: Foam
 Finish: FlexPlus™ Coated or Upholstered

Dimensions: FlexPlus List Price \$605
 W: 18
 D: 18
 H: 6
 SH: 6

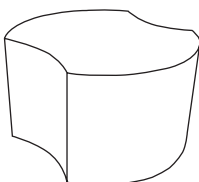

Model: Bubble 3 12"
Weight: Approx 15 lbs.
 Base UPH: Zipper or Wood w/Plastic Glides
 Base Coated: FlexPlus™ Coated Wood
 Glides: Plastic (Black)
 Metal Leg Finish: Powder Coated
 Material: Foam
 Finish: FlexPlus™ Coated or Upholstered

Dimensions: FlexPlus List Price \$765
 W: 18
 D: 18
 H: 12
 SH: 12
 FlexPlus w/Metal Legs List Price \$900
Overall Finished Height w/Metal Legs is 12

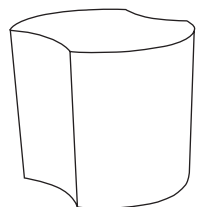

Model: Bubble 3 18"
Weight: Approx 20 lbs.
 Base UPH: Zipper or Wood w/Plastic Glides
 Base Coated: FlexPlus™ Coated Wood
 Glides: Plastic (Black)
 Metal Leg Finish: Powder Coated
 Material: Foam
 Finish: FlexPlus™ Coated or Upholstered

Dimensions: FlexPlus List Price \$945
 W: 18
 D: 18
 H: 18
 SH: 18
 FlexPlus w/Metal Legs List Price \$1,050
Overall Finished Height w/Metal Legs is 18

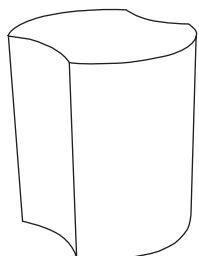

Model: Bubble 3 24"
Weight: Approx 25 lbs.
 Base UPH: Zipper or Wood w/Plastic Glides
 Base Coated: FlexPlus™ Coated Wood
 Glides: Plastic (Black)
 Material: Foam
 Finish: FlexPlus™ Coated or Upholstered

Dimensions: FlexPlus List Price \$1,115
 W: 18
 D: 18
 H: 24
 SH: 24

* 24" Bubble ottomans can not add metal legs or casters
 * Can not add casters to metal legs

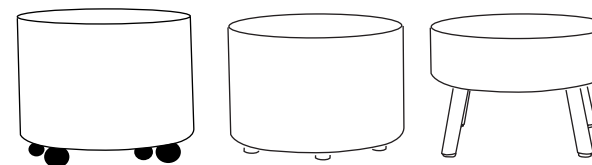

SHOWN: CASTERS / GLIDES / METAL LEGS

Upgrades
 Add to List Price
 +\$225 Casters (add 1.2" to overall height)

Bubble 3	Yardage	COM	A	B	C	D	E	F	G	H	I
Bubble 6" Zipper	1	\$397	\$430	\$447	\$470	\$490	\$517	\$550	\$584	\$646	\$699
Bubble 6" Wood Base/glides	1	\$405	\$438	\$455	\$478	\$498	\$525	\$558	\$592	\$654	\$707
Bubble 12" Zipper	1	\$475	\$508	\$525	\$548	\$568	\$595	\$628	\$662	\$724	\$777
Bubble 12" Wood Base/glides	1	\$485	\$518	\$535	\$558	\$578	\$605	\$638	\$672	\$734	\$787
Bubble 12" Metal legs	1	\$850	\$883	\$900	\$923	\$943	\$970	\$1,003	\$1,037	\$1,099	\$1,152
Bubble 18" Zipper	2	\$586	\$653	\$686	\$733	\$773	\$826	\$893	\$959	\$1,084	\$1,190
Bubble 18" Wood Base/glides	2	\$571	\$638	\$671	\$718	\$758	\$811	\$878	\$944	\$1,069	\$1,175
Bubble 18" Metal legs	2	\$934	\$1,001	\$1,034	\$1,081	\$1,121	\$1,174	\$1,241	\$1,307	\$1,432	\$1,538
Bubble 24" Zipper	2	\$659	\$726	\$759	\$806	\$846	\$899	\$966	\$1,032	\$1,157	\$1,263
Bubble 24" Wood Base/glides	2	\$652	\$719	\$752	\$799	\$839	\$892	\$959	\$1,025	\$1,150	\$1,256

* Can not add casters to metal legs

BUBBLE 4

Designed by SIXINCH® USA

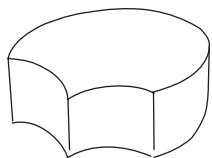

Model: Bubble 4 6"
Weight: Approx 10 lbs.
Base UPH: Zipper or Wood w/Plastic Glides
Base Coated: FlexPlus™ Coated Wood
Glides: Plastic (Black)
Material: Foam
Finish: FlexPlus™ Coated or Upholstered

Dimensions: FlexPlus List Price \$605

W: 18
D: 18
H: 6
SH: 6

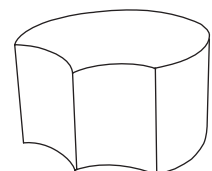

Model: Bubble 4 12"
Weight: Approx 15 lbs.
Base UPH: Zipper or Wood w/Plastic Glides
Base Coated: FlexPlus™ Coated Wood
Glides: Plastic (Black)
Material: Foam
Finish: FlexPlus™ Coated or Upholstered

Dimensions: FlexPlus List Price \$765

W: 18
D: 18
H: 12
SH: 12

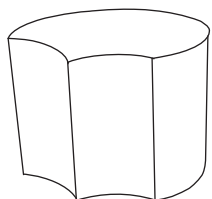

Model: Bubble 4 18"
Weight: Approx 20 lbs.
Base UPH: Zipper or Wood w/Plastic Glides
Base Coated: FlexPlus™ Coated Wood
Glides: Plastic (Black)
Material: Foam
Finish: FlexPlus™ Coated or Upholstered

Dimensions: FlexPlus List Price \$945

W: 18
D: 18
H: 18
SH: 18

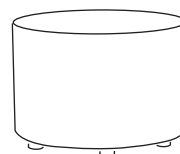

SHOWN: GLIDES

Bubble 4	Yardage	COM	A	B	C	D	E	F	G	H	I
Bubble 6" Zipper	1	\$397	\$430	\$447	\$470	\$490	\$517	\$550	\$584	\$646	\$699
Bubble 6" Wood Base/glides	1	\$405	\$438	\$455	\$478	\$498	\$525	\$558	\$592	\$654	\$707
Bubble 12" Wood Base/glides	1	\$485	\$518	\$535	\$558	\$578	\$605	\$638	\$672	\$734	\$787
Bubble 18" Zipper	2	\$586	\$653	\$686	\$733	\$773	\$826	\$893	\$959	\$1,084	\$1,190
Bubble 18" Wood Base/glides	2	\$571	\$638	\$671	\$718	\$758	\$811	\$878	\$944	\$1,069	\$1,175

* Bubble 4 ottomans can not add casters or metal legs

* Bubble 4 ottomans can not exceed 18"

BLOCK 1

Designed by SIXINCH® Design

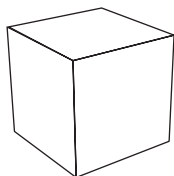

Model: Block 1
Weight: Approx 25 lbs.
Base UPH: Zipper or Wood w/Plastic Glides
Base Coated: FlexPlus™ Coated Wood
Glides: Plastic (Black)
Material: Foam
Finish: FlexPlus™ Coated or Upholstered
Quick Ship: FlexPlus™ Coated

Dimensions: FlexPlus List Price \$920

W: 18
 D: 18
 H: 19
 SH: 19

Upgrades
[Add to List Price](#)
 +\$225 Casters

Block 1 Upholstered	Yardage	COM	A	B	C	D	E	F	G	H	I
Blocks 1 w/zipper	2	\$460	\$527	\$560	\$607	\$647	\$700	\$767	\$833	\$958	\$1,064
Blocks 1 w/plastic glides	2	\$545	\$612	\$645	\$692	\$732	\$785	\$852	\$918	\$1,043	\$1,149

BLOCK 2

Designed by SIXINCH® Design

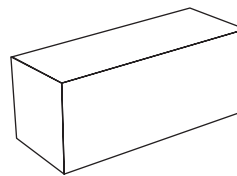

Model: Block 2
Weight: Approx 30 lbs.
Base UPH: Zipper or Wood w/Plastic Glides
Base Coated: FlexPlus™ Coated Wood
Glides: Plastic (Black)
Material: Foam
Finish: FlexPlus™ Coated or Upholstered
Quick Ship: FlexPlus™ Coated

Dimensions: FlexPlus List Price \$1,600

W: 36
 D: 18
 H: 19
 SH: 19

Upgrades
[Add to List Price](#)
 +\$225 Casters

Block 2 Upholstered	Yardage	COM	A	B	C	D	E	F	G	H	I
Blocks 2 w/zipper	3	\$994	\$1,094	\$1,144	\$1,214	\$1,274	\$1,354	\$1,454	\$1,554	\$1,741	\$1,901
Blocks 2 w/plastic glides	3	\$842	\$942	\$992	\$1,062	\$1,122	\$1,202	\$1,302	\$1,402	\$1,589	\$1,749

H POUF

Designed by SIXINCH® Design

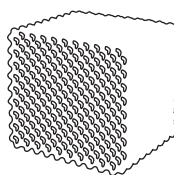

Model: H Pouf
Weight: Approx 20 lbs.
Base: FlexPlus™ Coated Wood
Glides: Plastic (Black)
Material: Foam
Finish: FlexPlus™ Coated

Dimensions: FlexPlus List Price \$1,775

W: 18
 D: 18
 H: 19.5
 SH: 19.5

PUZZLE 1

Designed by SIXINCH® Design

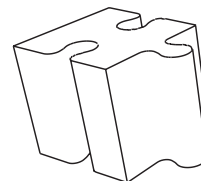

Model: Puzzle 1
Weight: Approx 22 lbs.
Base UPH: Zipper or Wood w/Plastic Glides
Base Coated: FlexPlus™ Coated Wood
Glides: Plastic (Black)
Material: Foam
Finish: FlexPlus™ Coated or Upholstered
Quick Ship: FlexPlus™ Coated

Dimensions: FlexPlus List Price \$1,080

W: 16
 D: 21.5
 H: 17.5
 SH: 17.5

Puzzle - Upholstered	Yardage	COM	A	B	C	D	E	F	G	H	I
Zipper 1,4,5	2	\$745	\$812	\$845	\$892	\$932	\$985	\$1,052	\$1,118	\$1,243	\$1,349
Zipper 2,3	2	\$863	\$930	\$963	\$1,010	\$1,050	\$1,103	\$1,170	\$1,236	\$1,361	\$1,467
Wood base w/glides 1,4,5	2	\$658	\$725	\$758	\$805	\$845	\$898	\$965	\$1,031	\$1,156	\$1,262
Wood base w/glides 2,3	2	\$719	\$786	\$819	\$866	\$906	\$959	\$1,026	\$1,092	\$1,217	\$1,323

Inventoried / Color and options limited
 Lead time varies 10-15 days - call for details

PUZZLE 2



Designed by SIXINCH® Design

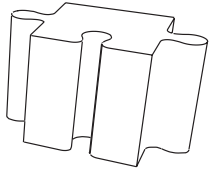

Model: Puzzle 2
Weight: Approx 22 lbs.
Base UPH: Zipper or Wood w/Plastic Glides
Base Coated: FlexPlus™ Coated Wood
Glides: Plastic (Black)
Material: Foam
Finish: FlexPlus™ Coated or Upholstered
Quick Ship: FlexPlus™ Coated

Dimensions: **FlexPlus List Price \$1,265**
W: 16
D: 27
H: 17.5
SH: 17.5

Puzzle - Upholstered	Yardage	COM	A	B	C	D	E	F	G	H	I
Zipper 1,4,5	2	\$745	\$812	\$845	\$892	\$932	\$985	\$1,052	\$1,118	\$1,243	\$1,349
Zipper 2,3	2	\$863	\$930	\$963	\$1,010	\$1,050	\$1,103	\$1,170	\$1,236	\$1,361	\$1,467
Wood base w/glides 1,4,5	2	\$658	\$725	\$758	\$805	\$845	\$898	\$965	\$1,031	\$1,156	\$1,262
Wood base w/glides 2,3	2	\$719	\$786	\$819	\$866	\$906	\$959	\$1,026	\$1,092	\$1,217	\$1,323

PUZZLE 3

Designed by SIXINCH® Design

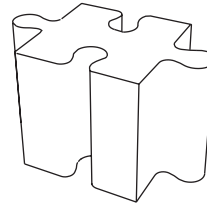

Model: Puzzle 3
Weight: Approx 22 lbs.
Base UPH: Zipper or Wood w/Plastic Glides
Base Coated: FlexPlus™ Coated Wood
Glides: Plastic (Black)
Material: Foam
Finish: FlexPlus™ Coated or Upholstered

Dimensions: **FlexPlus List Price \$1,265**
W: 16
D: 27
H: 17.5
SH: 17.5

Puzzle - Upholstered	Yardage	COM	A	B	C	D	E	F	G	H	I
Zipper 1,4,5	2	\$745	\$812	\$845	\$892	\$932	\$985	\$1,052	\$1,118	\$1,243	\$1,349
Zipper 2,3	2	\$863	\$930	\$963	\$1,010	\$1,050	\$1,103	\$1,170	\$1,236	\$1,361	\$1,467
Wood base w/glides 1,4,5	2	\$658	\$725	\$758	\$805	\$845	\$898	\$965	\$1,031	\$1,156	\$1,262
Wood base w/glides 2,3	2	\$719	\$786	\$819	\$866	\$906	\$959	\$1,026	\$1,092	\$1,217	\$1,323

PUZZLE 4

Designed by SIXINCH® Design

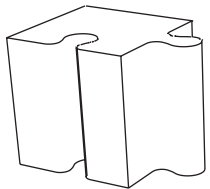

Model: Puzzle 4
Weight: Approx 22 lbs.
Base UPH: Zipper or Wood w/Plastic Glides
Base Coated: FlexPlus™ Coated Wood
Glides: Plastic (Black)
Material: Foam
Finish: FlexPlus™ Coated or Upholstered

Dimensions: **FlexPlus List Price \$1,080**
W: 16
D: 21.5
H: 17.5
SH: 17.5

Puzzle - Upholstered	Yardage	COM	A	B	C	D	E	F	G	H	I
Zipper 1,4,5	2	\$745	\$812	\$845	\$892	\$932	\$985	\$1,052	\$1,118	\$1,243	\$1,349
Zipper 2,3	2	\$863	\$930	\$963	\$1,010	\$1,050	\$1,103	\$1,170	\$1,236	\$1,361	\$1,467
Wood base w/glides 1,4,5	2	\$658	\$725	\$758	\$805	\$845	\$898	\$965	\$1,031	\$1,156	\$1,262
Wood base w/glides 2,3	2	\$719	\$786	\$819	\$866	\$906	\$959	\$1,026	\$1,092	\$1,217	\$1,323

PUZZLE 5

Designed by SIXINCH® Design

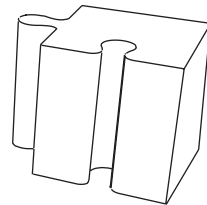

Model: Puzzle 5
Weight: Approx 22 lbs.
Base UPH: Zipper or Wood w/Plastic Glides
Base Coated: FlexPlus™ Coated Wood
Glides: Plastic (Black)
Material: Foam
Finish: FlexPlus™ Coated or Upholstered

Dimensions: **FlexPlus List Price \$1,080**
W: 16
D: 21.5
H: 17.5
SH: 17.5

Puzzle - Upholstered	Yardage	COM	A	B	C	D	E	F	G	H	I
Zipper 1,4,5	2	\$745	\$812	\$845	\$892	\$932	\$985	\$1,052	\$1,118	\$1,243	\$1,349
Zipper 2,3	2	\$863	\$930	\$963	\$1,010	\$1,050	\$1,103	\$1,170	\$1,236	\$1,361	\$1,467
Wood base w/glides 1,4,5	2	\$658	\$725	\$758	\$805	\$845	\$898	\$965	\$1,031	\$1,156	\$1,262
Wood base w/glides 2,3	2	\$719	\$786	\$819	\$866	\$906	\$959	\$1,026	\$1,092	\$1,217	\$1,323

CUSH'N

Designed by SIXINCH® USA

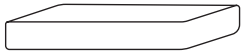

Model: Cush'N
Weight: Approx 4 lbs.
Base UPH: Wood w/Plastic Glides
Base Coated: FlexPlus™ foam
Material: Foam
Finish: FlexPlus™ Coated or Upholstered

Dimensions: **FlexPlus List Price \$600**
 W: 16
 D: 14
 H: 3

Cush'N - Upholstered	Yardage	COM	A	B	C	D	E	F	G	H	I
	0.5	\$231	\$248	\$256	\$268	\$278	\$291	\$308	\$324	\$355	\$382

HEX POUF 12"

Designed by SIXINCH® USA

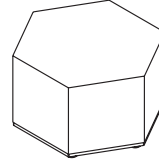

Model: Hex Pouf 12"
Weight: Approx 15 lbs.
Base UPH: Wood w/Glides
Base Coated: FlexPlus™ Coated Wood w/Glides
Glides: Plastic (Black)
Material: Foam
Finish: FlexPlus™ Coated or Upholstered

Dimensions: **FlexPlus List Price \$965**
 W: 18.5
 D: 21
 H: 12
 SH: 12

Upgrades
[Add to List Price](#)
+\$270 Casters (adds 1.2")

Hex Pouf - Upholstered	Yardage	COM	A	B	C	D	E	F	G	H	I
Hex Pouf 12"	1.5	\$554	\$604	\$629	\$664	\$694	\$734	\$784	\$834	\$927	\$1,007

HEX POUF 6"

Designed by SIXINCH® USA

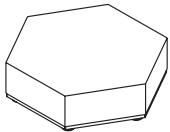

Model: Hex Pouf 6"
Weight: Approx 10 lbs.
Base UPH: Wood w/Glides
Base Coated: FlexPlus™ Coated Wood w/Glides
Glides: Plastic (Black)
Material: Foam
Finish: FlexPlus™ Coated or Upholstered

Dimensions: **FlexPlus List Price \$745**
 W: 18.5
 D: 21
 H: 6
 SH: 6

Upgrades
[Add to List Price](#)
+\$270 Casters (adds 1.2")

Hex Pouf - Upholstered	Yardage	COM	A	B	C	D	E	F	G	H	I
Hex Pouf 6"	1	\$465	\$498	\$515	\$538	\$558	\$585	\$618	\$652	\$714	\$767

HEX POUF 18"

Designed by SIXINCH® USA

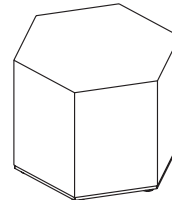

Model: Hex Pouf 18"
Weight: Approx 20 lbs.
Base UPH: Wood w/Glides
Base Coated: FlexPlus™ Coated Wood w/Glides
Glides: Plastic (Black)
Material: Foam
Finish: FlexPlus™ Coated or Upholstered

Dimensions: **FlexPlus List Price \$1,160**
 W: 18.5
 D: 21
 H: 18
 SH: 18

Upgrades
[Add to List Price](#)
+\$270 Casters (adds 1.2")

Hex Pouf - Upholstered	Yardage	COM	A	B	C	D	E	F	G	H	I
Hex Pouf 18"	1.5	\$625	\$675	\$700	\$735	\$765	\$805	\$855	\$905	\$998	\$1,078

HEX ARROW 6"

Designed by SIXINCH® USA

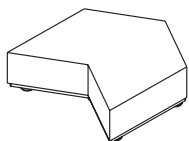

Model: Hex Arrow 6"
Weight: Approx 10 lbs.
Base UPH: Wood w/Glides
Base Coated: FlexPlus™ Coated Wood w/Glides
Glides: Plastic (Black)
Material: Foam
Finish: FlexPlus™ Coated or Upholstered

Dimensions: **FlexPlus List Price \$715**

W: 18.5
D: 21
H: 6
SH: 6

Upgrades
[Add to List Price](#)

+\$270 Casters (adds 1.2")

Hex Arrow - Upholstered	Yardage	COM	A	B	C	D	E	F	G	H	I
Hex Arrow 6"	1	\$467	\$500	\$517	\$540	\$560	\$587	\$620	\$654	\$716	\$769

HEX ARROW 12"

Designed by SIXINCH® USA

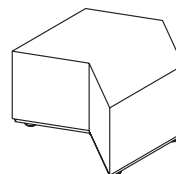

Model: Hex Arrow 12"
Weight: Approx 15 lbs.
Base UPH: Wood w/Glides
Base Coated: FlexPlus™ Coated Wood w/Glides
Glides: Plastic (Black)
Material: Foam
Finish: FlexPlus™ Coated or Upholstered

Dimensions: **FlexPlus List Price \$930**

W: 18.5
D: 21
H: 12
SH: 12

Upgrades
[Add to List Price](#)

+\$270 Casters (adds 1.2")

Hex Arrow - Upholstered	Yardage	COM	A	B	C	D	E	F	G	H	I
Hex Arrow 12"	1.5	\$543	\$593	\$618	\$653	\$683	\$723	\$773	\$823	\$916	\$996

HEX ARROW 18"

Designed by SIXINCH® USA

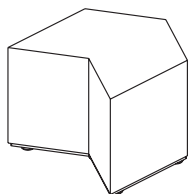

Model: Hex Arrow 18"
Weight: Approx 20 lbs.
Base UPH: Wood w/Glides
Base Coated: FlexPlus™ Coated Wood w/Glides
Glides: Plastic (Black)
Material: Foam
Finish: FlexPlus™ Coated or Upholstered

Dimensions: **FlexPlus List Price \$1,145**

W: 18.5
D: 21
H: 18
SH: 18

Upgrades
[Add to List Price](#)

+\$270 Casters (adds 1.2")

Hex Arrow - Upholstered	Yardage	COM	A	B	C	D	E	F	G	H	I
Hex Arrow 18"	1.5	\$574	\$624	\$649	\$684	\$714	\$754	\$804	\$854	\$947	\$1,027

ROBLOCK

Designed by SIXINCH® Design

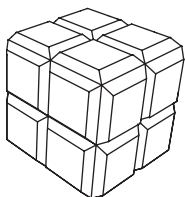

Model: Roblock
Weight: Approx 25 lbs.
Base: FlexPlus™ Coated Wood
Glides: Plastic (Black)
Material: Foam
Finish: FlexPlus™ Coated

Dimensions: **FlexPlus List Price \$1,585**
 W: 19
 D: 19
 H: 20.5
 SH: 20.5

ROBLOCK 4

Designed by SIXINCH® Design

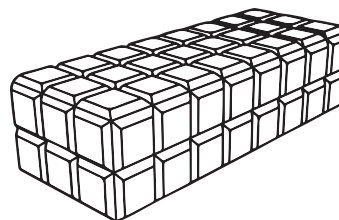

Model: Roblock 4
Weight: Approx 90 lbs.
Base: FlexPlus™ Coated Wood
Glides: Plastic (Black)
Material: Foam
Finish: FlexPlus™ Coated

Dimensions: **FlexPlus List Price \$7,130**
 W: 73
 D: 28
 H: 20.5
 SH: 20.5

ROBLOCK 2

Designed by SIXINCH® Design

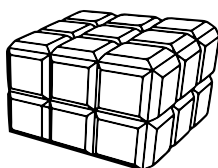

Model: Roblock 2
Weight: Approx 35 lbs.
Base: FlexPlus™ Coated Wood
Glides: Plastic (Black)
Material: Foam
Finish: FlexPlus™ Coated

Dimensions: **FlexPlus List Price \$3,070**
 W: 28
 D: 28
 H: 20.5
 SH: 20.5

ROBLOCK 5

Designed by SIXINCH® Design

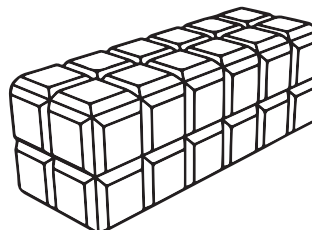

Model: Roblock 5
Weight: Approx 50 lbs.
Base: FlexPlus™ Coated Wood
Glides: Plastic (Black)
Material: Foam
Finish: FlexPlus™ Coated

Dimensions: **FlexPlus List Price \$3,780**
 W: 55
 D: 19
 H: 20.5
 SH: 20.5

ROBLOCK 3

Designed by SIXINCH® Design

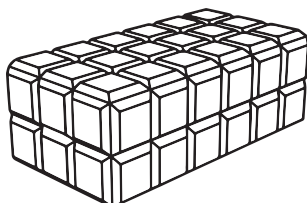

Model: Roblock 3
Weight: Approx 70 lbs.
Base: FlexPlus™ Coated Wood
Glides: Plastic (Black)
Material: Foam
Finish: FlexPlus™ Coated

Dimensions: **FlexPlus List Price \$4,585**
 W: 44
 D: 28
 H: 20.5
 SH: 20.5

ROBLOCK 6

Designed by SIXINCH® Design

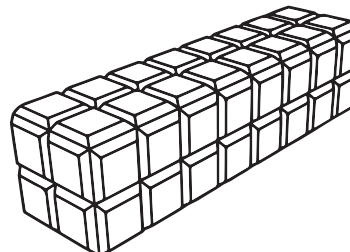

Model: Roblock 6
Weight: Approx 60 lbs.
Base: FlexPlus™ Coated Wood
Glides: Plastic (Black)
Material: Foam
Finish: FlexPlus™ Coated

Dimensions: **FlexPlus List Price \$5,380**
 W: 73
 D: 19
 H: 20.5
 SH: 20.5

DIAMOND POUF 1

Designed by SIXINCH® Design

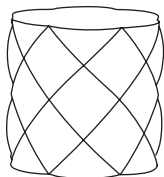

Model: Diamond Pouf 1
Weight: Approx 26 lbs.
Base: FlexPlus™ Coated Wood
Glides: Plastic (Black)
Material: Foam
Finish: FlexPlus™ Coated

Dimensions: **FlexPlus List Price \$1,540**
W: 20.5
D: 20.5
H: 19.5
SH: 19.5

DIAMOND POUF 2

Designed by SIXINCH® Design

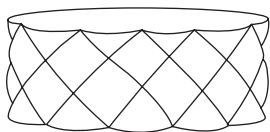

Model: Diamond Pouf 2
Weight: Approx
Base: FlexPlus™ Coated Wood
Glides: Plastic (Black)
Material: Foam
Finish: FlexPlus™ Coated

Dimensions: **FlexPlus List Price \$3,200**
W: 33
D: 33
H: 15
SH: 15

DIAMOND POUF 3

Designed by SIXINCH® Design

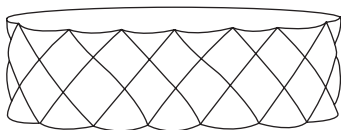

Model: Diamond Pouf 3
Weight: Approx
Base: FlexPlus™ Coated Wood
Glides: Plastic (Black)
Material: Foam
Finish: FlexPlus™ Coated

Dimensions: **FlexPlus List Price \$5,810**
W: 48.5
D: 48.5
H: 15
SH: 15

STEEN POUF



Designed by SIXINCH® Design

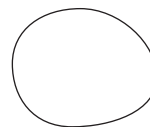

Model: Steen Pouf
Weight: Approx 25 lbs.
Base UPH: Wood w/Plastic Glides
Base Coated: FlexPlus™ Coated Wood
Glides: Plastic (Black)
Material: Molded Foam
Finish: FlexPlus™ Coated or Upholstered
Quick Ship: FlexPlus™ Coated

Dimensions: **FlexPlus List Price \$1,625**
W: 27.5
D: 19.5
H: 14.5
SH: 14.5

Pouf - Upholstered	Yardage	COM	A	B	C	D	E	F	G	H	I
	1.25	\$900	\$942	\$962	\$992	\$1,017	\$1,050	\$1,092	\$1,133	\$1,211	\$1,278

STEEN TABLE

Designed by SIXINCH® Design

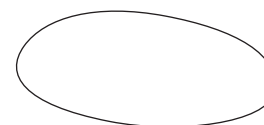

Model: Steen Table
Weight: Approx 50 lbs.
Base UPH: Wood w/Plastic Glides
Base Coated: FlexPlus™ Coated Wood
Glides: Plastic (Black)
Material: Molded Foam
Finish: FlexPlus™ Coated or Upholstered

Dimensions: **FlexPlus List Price \$2,645**
W: 43
D: 27
H: 12.5
SH: 12.5

Table - Upholstered	Yardage	COM	A	B	C	D	E	F	G	H	I
	2	\$1,500	\$1,567	\$1,600	\$1,647	\$1,687	\$1,740	\$1,807	\$1,873	\$1,998	\$2,104

STEEN SOFA

Designed by SIXINCH® Design

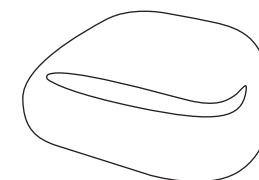

Model: Steen Sofa
Weight: Approx 120 lbs.
Base UPH: Wood w/Plastic Glides
Base Coated: FlexPlus™ Coated Wood
Glides: Plastic (Black)
Material: Molded Foam
Finish: FlexPlus™ Coated or Upholstered

Dimensions: **FlexPlus List Price \$4,875**
W: 59
D: 39
H: 25
SH: 13
SD: 20.5

Sofa - Upholstered	Yardage	COM	A	B	C	D	E	F	G	H	I
	3.75	\$3,000	\$3,125	\$3,187	\$3,275	\$3,350	\$3,450	\$3,575	\$3,700	\$3,933	\$4,133

TWIST LOUNGE

Designed by SIXINCH® Design

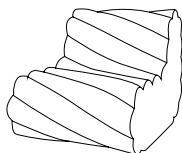

Model: Twist Lounge
Weight: TBD
Base: FlexPlus™ Coated Wood
Glides: Plastic (Black)
Material: Foam
Finish: FlexPlus™ Coated

Dimensions: FlexPlus List Price \$7,000
W: 24
D: 35
H: 35
SH: 17.5

TWIST BENCH 1

Designed by SIXINCH® Design

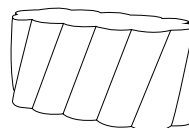

Model: Twist Bench 1
Weight: TBD
Base: FlexPlus™ Coated Wood
Glides: Plastic (Black)
Material: Foam
Finish: FlexPlus™ Coated

Dimensions: FlexPlus List Price \$5,000
W: 40
D: 17.5
H: 17.5
SH: 17.5

TWIST SETTEE

Designed by SIXINCH® Design

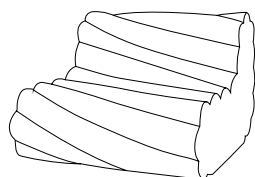

Model: Twist Settee
Weight: TBD
Base: FlexPlus™ Coated Wood
Glides: Plastic (Black)
Material: Foam
Finish: FlexPlus™ Coated

Dimensions: FlexPlus List Price \$13,275
W: 48
D: 35
H: 35
SH: 17.5

TWIST BENCH 2

Designed by SIXINCH® Design

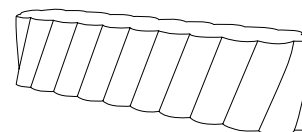

Model: Twist Bench 2
Weight: TBD
Base: FlexPlus™ Coated Wood
Glides: Plastic (Black)
Material: Foam
Finish: FlexPlus™ Coated

Dimensions: FlexPlus List Price \$7,500
W: 76.5
D: 17.5
H: 17.5
SH: 17.5

TWIST OTTOMAN

Designed by SIXINCH® Design

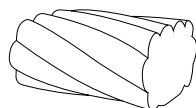

Model: Twist Ottoman
Weight: TBD
Base: FlexPlus™ Coated Wood
Glides: Plastic (Black)
Material: Foam
Finish: FlexPlus™ Coated

Dimensions: FlexPlus List Price \$4,500
W: 24
D: 32
H: 17.5
SH: 17.5

TWIST POUF 1

Designed by SIXINCH® Design



Model: Twist Pouf 1
Weight: TBD
Base: FlexPlus™ Coated Wood
Glides: Plastic (Black)
Material: Foam
Finish: FlexPlus™ Coated

Dimensions: FlexPlus List Price \$3,010
W: 17.5
D: 17.5
H: 17.5
SH: 17.5

TWIST BRAID

Designed by SIXINCH® Design



Model: Twist Ottoman
Weight: TBD
Base: FlexPlus™ Coated Wood
Glides: Plastic (Black)
Material: Foam
Finish: FlexPlus™ Coated

Dimensions: FlexPlus List Price \$8,650
W: 70
D: 17.5
H: 17.5
SH: 17.5

TWIST POUF 2

Designed by SIXINCH® Design

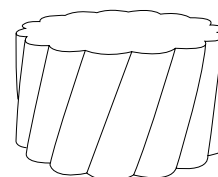

Model: Twist Pouf 2
Weight: TBD
Base: FlexPlus™ Coated Wood
Glides: Plastic (Black)
Material: Foam
Finish: FlexPlus™ Coated

Dimensions: FlexPlus List Price \$5,500
W: 40
D: 17.5
H: 17.5
SH: 17.5

BENCH 1

Designed by SIXINCH® Design

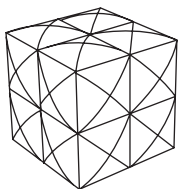

Model: Bench 1
Weight: Approx 25 lbs.
Base: FlexPlus™ Coated Wood
Glides: Plastic (Black)
Material: Foam
Finish: FlexPlus™ Coated

Dimensions: **FlexPlus List Price \$1,650**
W: 20
D: 20
H: 20.5
SH: 20.5

BENCH 4

Designed by SIXINCH® Design

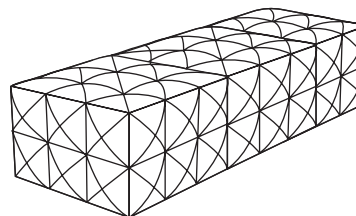

Model: Bench 4
Weight: Approx
Base: FlexPlus™ Coated Wood
Glides: Plastic (Black)
Material: Foam
Finish: FlexPlus™ Coated

Dimensions: **FlexPlus List Price \$5,680**
W: 72
D: 28.5
H: 20.5
SH: 20.5

BENCH 2

Designed by SIXINCH® Design

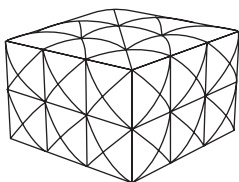

Model: Bench 2
Weight: Approx
Base: FlexPlus™ Coated Wood
Glides: Plastic (Black)
Material: Foam
Finish: FlexPlus™ Coated

Dimensions: **FlexPlus List Price \$2,665**
W: 28.5
D: 28.5
H: 20.5
SH: 20.5

BENCH 5

Designed by SIXINCH® Design

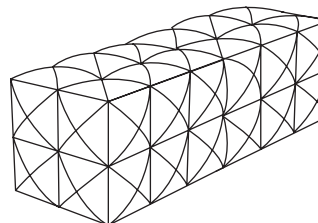

Model: Bench 5
Weight: Approx 50 lbs.
Base: FlexPlus™ Coated Wood
Glides: Plastic (Black)
Material: Foam
Finish: FlexPlus™ Coated

Dimensions: **FlexPlus List Price \$3,495**
W: 54.5
D: 20
H: 20.5
SH: 20.5

BENCH 3

Designed by SIXINCH® Design

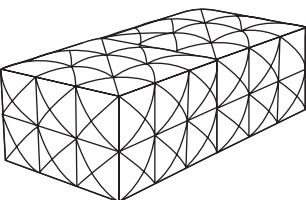

Model: Bench 3
Weight: Approx
Base: FlexPlus™ Coated Wood
Glides: Plastic (Black)
Material: Foam
Finish: FlexPlus™ Coated

Dimensions: **FlexPlus List Price \$4,875**
W: 54.5
D: 28.5
H: 20.5
SH: 20.5

BENCH 6

Designed by SIXINCH® Design

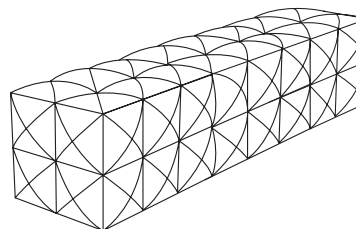

Model: Bench 6
Weight: Approx 60 lbs.
Base: FlexPlus™ Coated Wood
Glides: Plastic (Black)
Material: Foam
Finish: FlexPlus™ Coated

Dimensions: **FlexPlus List Price \$4,415**
W: 72
D: 20
H: 20.5
SH: 20.5

A

Designed by SIXINCH® Design

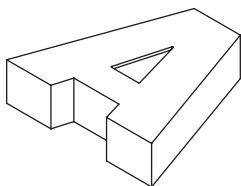

Model: Letter A
Weight: Approx 125 lbs.
Base: FlexPlus™ Coated Wood
Glides: Plastic (Black)
Material: Foam
Finish: FlexPlus™ Coated

Dimensions: **FlexPlus List Price \$5,085**
 W: 58
 D: 55
 H: 16.5
 SH: 16.5

D

Designed by SIXINCH® Design

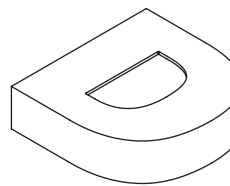

Model: Letter D
Weight: Approx
Base: FlexPlus™ Coated Wood
Glides: Plastic (Black)
Material: Foam
Finish: FlexPlus™ Coated

Dimensions: **FlexPlus List Price \$5,275**
 W: 53
 D: 55
 H: 16.5
 SH: 16.5

B

Designed by SIXINCH® Design

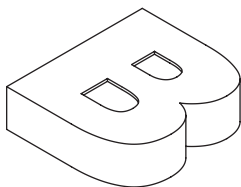

Model: Letter B
Weight: Approx
Base: FlexPlus™ Coated Wood
Glides: Plastic (Black)
Material: Foam
Finish: FlexPlus™ Coated

Dimensions: **FlexPlus List Price \$5,440**
 W: 50
 D: 55
 H: 16.5
 SH: 16.5

E

Designed by SIXINCH® Design

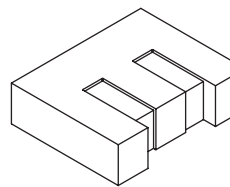

Model: Letter E
Weight: Approx
Base: FlexPlus™ Coated Wood
Glides: Plastic (Black)
Material: Foam
Finish: FlexPlus™ Coated

Dimensions: **FlexPlus List Price \$5,000**
 W: 45.5
 D: 55
 H: 16.5
 SH: 16.5

C

Designed by SIXINCH® Design

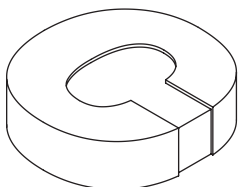

Model: Letter C
Weight: Approx
Base: FlexPlus™ Coated Wood
Glides: Plastic (Black)
Material: Foam
Finish: FlexPlus™ Coated

Dimensions: **FlexPlus List Price \$5,435**
 W: 55
 D: 58
 H: 16.5
 SH: 16.5

F

Designed by SIXINCH® Design

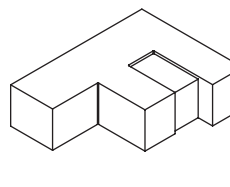

Model: Letter F
Weight: Approx
Base: FlexPlus™ Coated Wood
Glides: Plastic (Black)
Material: Foam
Finish: FlexPlus™ Coated

Dimensions: **FlexPlus List Price \$4,300**
 W: 42.5
 D: 55
 H: 16.5
 SH: 16.5

G

Designed by SIXINCH® Design

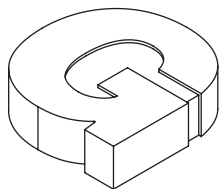

Model: Letter G
Weight: Approx
Base: FlexPlus™ Coated Wood
Glides: Plastic (Black)
Material: Foam
Finish: FlexPlus™ Coated

Dimensions: **FlexPlus List Price \$5,830**
W: 56
D: 58
H: 16.5
SH: 16.5

J

Designed by SIXINCH® Design

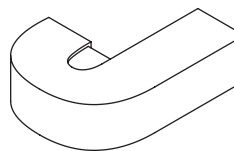

Model: Letter J
Weight: Approx
Base: FlexPlus™ Coated Wood
Glides: Plastic (Black)
Material: Foam
Finish: FlexPlus™ Coated

Dimensions: **FlexPlus List Price \$4,100**
W: 43.5
D: 56.5
H: 16.5
SH: 16.5

H

Designed by SIXINCH® Design

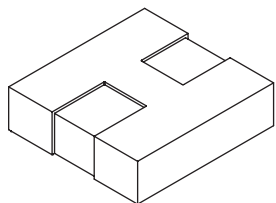

Model: Letter H
Weight: Approx
Base: FlexPlus™ Coated Wood
Glides: Plastic (Black)
Material: Foam
Finish: FlexPlus™ Coated

Dimensions: **FlexPlus List Price \$5,545**
W: 52.5
D: 55
H: 16.5
SH: 16.5

K

Designed by SIXINCH® Design

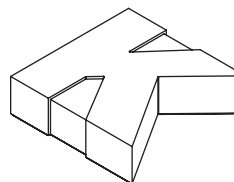

Model: Letter K
Weight: Approx
Base: FlexPlus™ Coated Wood
Glides: Plastic (Black)
Material: Foam
Finish: FlexPlus™ Coated

Dimensions: **FlexPlus List Price \$5,625**
W: 57
D: 55
H: 16.5
SH: 16.5

I

Designed by SIXINCH® Design

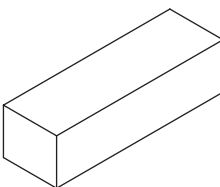

Model: Letter I
Weight: Approx
Base: FlexPlus™ Coated Wood
Glides: Plastic (Black)
Material: Foam
Finish: FlexPlus™ Coated

Dimensions: **FlexPlus List Price \$2,425**
W: 17.5
D: 55
H: 16.5
SH: 16.5

L

Designed by SIXINCH® Design

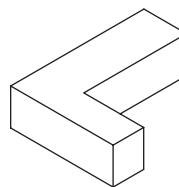

Model: Letter L
Weight: Approx
Base: FlexPlus™ Coated Wood
Glides: Plastic (Black)
Material: Foam
Finish: FlexPlus™ Coated

Dimensions: **FlexPlus List Price \$4,145**
W: 42.5
D: 55
H: 16.5
SH: 16.5

M

Designed by SIXINCH® Design

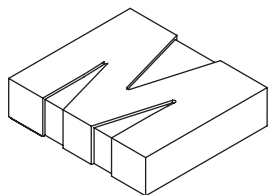

Model: Letter M
Weight: Approx
Base: FlexPlus™ Coated Wood
Glides: Plastic (Black)
Material: Foam
Finish: FlexPlus™ Coated

Dimensions: **FlexPlus List Price \$6,390**
 W: 62.5
 D: 55
 H: 16.5
 SH: 16.5

P

Designed by SIXINCH® Design

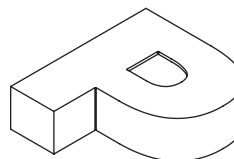

Model: Letter P
Weight: Approx
Base: FlexPlus™ Coated Wood
Glides: Plastic (Black)
Material: Foam
Finish: FlexPlus™ Coated

Dimensions: **FlexPlus List Price \$4,830**
 W: 50.5
 D: 55
 H: 16.5
 SH: 16.5

N

Designed by SIXINCH® Design

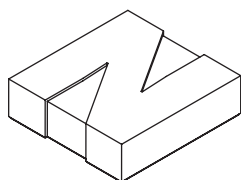

Model: Letter N
Weight: Approx
Base: FlexPlus™ Coated Wood
Glides: Plastic (Black)
Material: Foam
Finish: FlexPlus™ Coated

Dimensions: **FlexPlus List Price \$5,445**
 W: 52.5
 D: 55
 H: 16.5
 SH: 16.5

Q

Designed by SIXINCH® Design

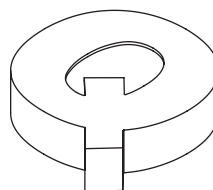

Model: Letter Q
Weight: Approx
Base: FlexPlus™ Coated Wood
Glides: Plastic (Black)
Material: Foam
Finish: FlexPlus™ Coated

Dimensions: **FlexPlus List Price \$6,090**
 W: 58
 D: 62.5
 H: 16.5
 SH: 16.5

O

Designed by SIXINCH® Design

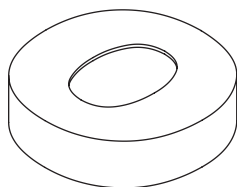

Model: Letter O
Weight: Approx
Base: FlexPlus™ Coated Wood
Glides: Plastic (Black)
Material: Foam
Finish: FlexPlus™ Coated

Dimensions: **FlexPlus List Price \$5,580**
 W: 58
 D: 58
 H: 16.5
 SH: 16.5

R

Designed by SIXINCH® Design

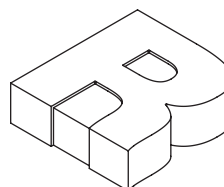

Model: Letter R
Weight: Approx
Base: FlexPlus™ Coated Wood
Glides: Plastic (Black)
Material: Foam
Finish: FlexPlus™ Coated

Dimensions: **FlexPlus List Price \$5,285**
 W: 52
 D: 55
 H: 16.5
 SH: 16.5

S

Designed by SIXINCH® Design

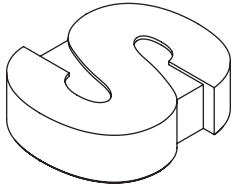

Model: Letter S
Weight: Approx
Base: FlexPlus™ Coated Wood
Glides: Plastic (Black)
Material: Foam
Finish: FlexPlus™ Coated

Dimensions: **FlexPlus List Price \$5,125**
 W: 50
 D: 58
 H: 16.5
 SH: 16.5

V

Designed by SIXINCH® Design

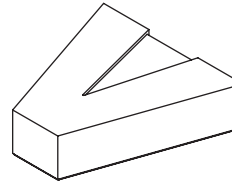

Model: Letter V
Weight: Approx
Base: FlexPlus™ Coated Wood
Glides: Plastic (Black)
Material: Foam
Finish: FlexPlus™ Coated

Dimensions: **FlexPlus List Price \$5,030**
 W: 56
 D: 55
 H: 16.5
 SH: 16.5

T

Designed by SIXINCH® Design

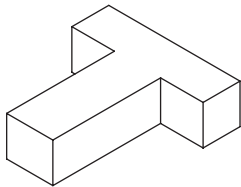

Model: Letter T
Weight: Approx
Base: FlexPlus™ Coated Wood
Glides: Plastic (Black)
Material: Foam
Finish: FlexPlus™ Coated

Dimensions: **FlexPlus List Price \$4,465**
 W: 50
 D: 55
 H: 16.5
 SH: 16.5

W

Designed by SIXINCH® Design

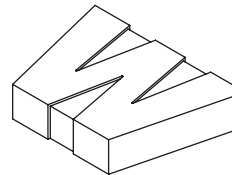

Model: Letter W
Weight: Approx
Base: FlexPlus™ Coated Wood
Glides: Plastic (Black)
Material: Foam
Finish: FlexPlus™ Coated

Dimensions: **FlexPlus List Price \$7,505**
 W: 75.5
 D: 55
 H: 16.5
 SH: 16.5

U

Designed by SIXINCH® Design

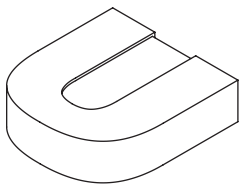

Model: Letter U
Weight: Approx
Base: FlexPlus™ Coated Wood
Glides: Plastic (Black)
Material: Foam
Finish: FlexPlus™ Coated

Dimensions: **FlexPlus List Price \$5,400**
 W: 52.5
 D: 56.5
 H: 16.5
 SH: 16.5

X

Designed by SIXINCH® Design

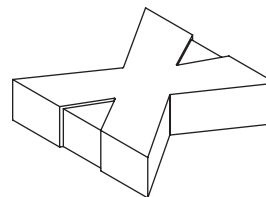

Model: Letter X
Weight: Approx
Base: FlexPlus™ Coated Wood
Glides: Plastic (Black)
Material: Foam
Finish: FlexPlus™ Coated

Dimensions: **FlexPlus List Price \$5,180**
 W: 58
 D: 55
 H: 16.5
 SH: 16.5

Y

Designed by SIXINCH® Design

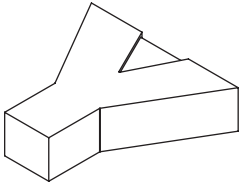

Model: Letter Y
Weight: Approx
Base: FlexPlus™ Coated Wood
Glides: Plastic (Black)
Material: Foam
Finish: FlexPlus™ Coated

Dimensions: **FlexPlus List Price \$4,745**
W: 58.5
D: 55
H: 16.5
SH: 16.5

Z

Designed by SIXINCH® Design

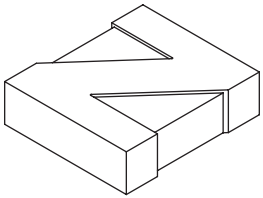

Model: Letter Z
Weight: Approx
Base: FlexPlus™ Coated Wood
Glides: Plastic (Black)
Material: Foam
Finish: FlexPlus™ Coated

Dimensions: **FlexPlus List Price \$5,035**
W: 49.5
D: 55
H: 16.5
SH: 16.5

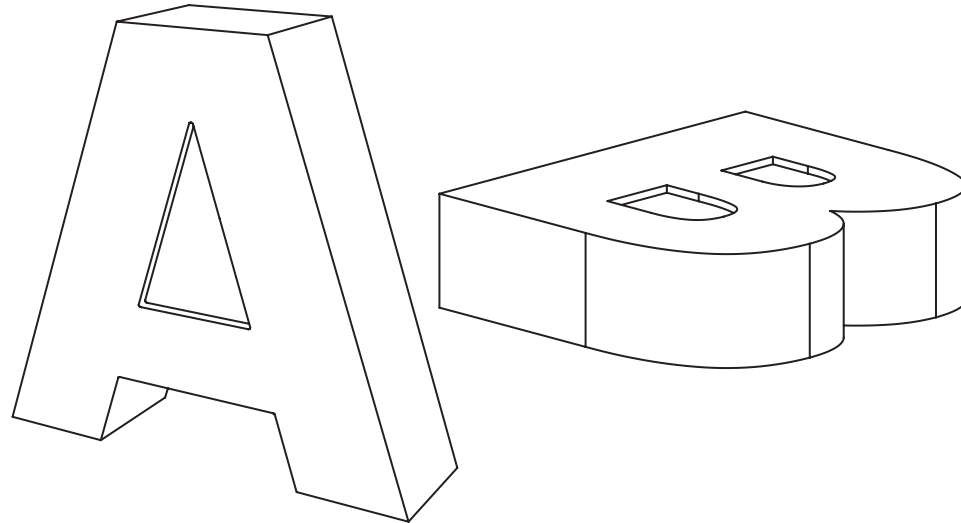

ARROW 1

Designed by SIXINCH® Design

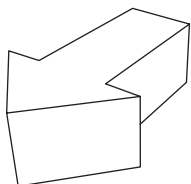

Model: Arrow 1
Weight: Approx
Base: FlexPlus™ Coated Wood
Glides: Plastic (Black)
Material: Foam
Finish: FlexPlus™ Coated or Upholstered

Dimensions: **FlexPlus List Price \$3,390**
W: 53
D: 35
H: 19.5
SH: 19.5

ARROW 4

Designed by SIXINCH® Design

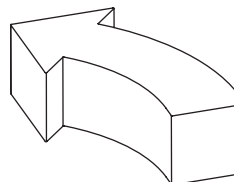

Model: Arrow 4
Weight: Approx
Base: FlexPlus™ Coated Wood
Glides: Plastic (Black)
Material: Foam
Finish: FlexPlus™ Coated or Upholstered

Dimensions: **FlexPlus List Price \$4,105**
W: 54
D: 38.5
H: 19.5
SH: 19.5

ARROW 2

Designed by SIXINCH® Design

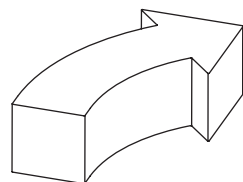

Model: Arrow 2
Weight: Approx 50 lbs.
Base: FlexPlus™ Coated Wood
Glides: Plastic (Black)
Material: Foam
Finish: FlexPlus™ Coated or Upholstered

Dimensions: **FlexPlus List Price \$4,105**
W: 54
D: 38.5
H: 19.5
SH: 19.5

ARROW 5

Designed by SIXINCH® Design

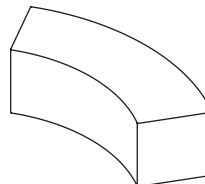

Model: Arrow 5
Weight: Approx
Base: FlexPlus™ Coated Wood
Glides: Plastic (Black)
Material: Foam
Finish: FlexPlus™ Coated or Upholstered

Dimensions: **FlexPlus List Price \$2,905**
W: 59
D: 23.5
H: 19.5
SH: 19.5

ARROW 3

Designed by SIXINCH® Design

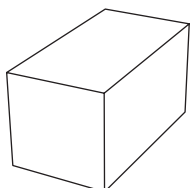

Model: Arrow 3
Weight: Approx
Base: FlexPlus™ Coated Wood
Glides: Plastic (Black)
Material: Foam
Finish: FlexPlus™ Coated or Upholstered

Dimensions: **FlexPlus List Price \$1,935**
W: 35.5
D: 18
H: 19.5
SH: 19.5

BEAR

Designed by SIXINCH® USA

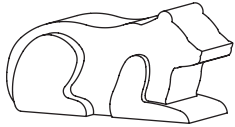

Model: Bear
Weight: Approx 25 lbs.
Base UPH: Wood w/Plastic Glides
Base Coated: FlexPlus™ Coated Wood
Glides: Plastic (Black)
Material: Foam
Finish: FlexPlus™ Coated or Upholstered

Dimensions: **FlexPlus List Price \$1,200**

W: 12.5
 D: 29.5
 H: 16
 SH: 16

Upgrades
 Add to List Price

+\$225 Casters (add 1.2" to overall height)

Bear - Upholstered	Yardage	COM	A	B	C	D	E	F	G	H	I
	2	\$661	\$728	\$761	\$808	\$854	\$901	\$968	\$1,034	\$1,159	\$1,265

CAT

Designed by SIXINCH® USA

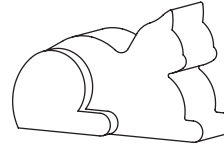

Model: Cat
Weight: Approx 25 lbs.
Base UPH: Wood w/Plastic Glides
Base Coated: FlexPlus™ Coated Wood
Glides: Plastic (Black)
Material: Foam
Finish: FlexPlus™ Coated or Upholstered
Quick Ship: FlexPlus™ Coated

Dimensions: **FlexPlus List Price \$1,050**

W: 12
 D: 24.5
 H: 17.5
 SH: 17.5

Upgrades
 Add to List Price

+\$225 Casters (add 1.2" to overall height)

Cat - Upholstered	Yardage	COM	A	B	C	D	E	F	G	H	I
	2	\$563	\$630	\$663	\$710	\$756	\$803	\$870	\$936	\$1,061	\$1,167

WRAPZ

Wrapz - Cat	List
Vinyl - Wood Base	\$1,000
Black Knit - Wood Base	\$1,100

CAMEL

Designed by SIXINCH® USA

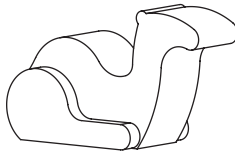

Model: Camel
Weight: Approx 25 lbs.
Base UPH: Wood w/Plastic Glides
Base Coated: FlexPlus™ Coated Wood
Glides: Plastic (Black)
Material: Foam
Finish: FlexPlus™ Coated or Upholstered

Dimensions: **FlexPlus List Price \$1,200**

W: 12
 D: 31.5
 H: 20
 SH: 20

Upgrades
 Add to List Price

+\$225 Casters (add 1.2" to overall height)

Camel - Upholstered	Yardage	COM	A	B	C	D	E	F	G	H	I
	2.25	\$663	\$738	\$775	\$828	\$880	\$933	\$1,008	\$1,083	\$1,223	\$1,343

DOG

Designed by SIXINCH® USA

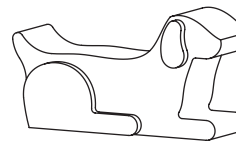

Model: Dog
Weight: Approx 25 lbs.
Base UPH: Wood w/Plastic Glides
Base Coated: FlexPlus™ Coated Wood
Glides: Plastic (Black)
Material: Foam
Finish: FlexPlus™ Coated or Upholstered
Quick Ship: FlexPlus™ Coated

Dimensions: **FlexPlus List Price \$1,050**

W: 10
 D: 30
 H: 17
 SH: 17

Upgrades
 Add to List Price

+\$225 Casters (add 1.2" to overall height)

Dog	Yardage	COM	A	B	C	D	E	F	G	H	I
Upholstered	2	\$621	\$688	\$721	\$768	\$814	\$861	\$928	\$994	\$1,119	\$1,225

WRAPZ

Dog WRAPZ	List
Vinyl - Wood Base	\$1000
Black Knit - Wood Base	\$1,100

Inventoried / Color and options limited
 Lead time varies 10-15 days - call for details

- List prices for FlexPlus™ coated products includes standard colors.
- Custom FlexPlus coating colors add \$500 net price per color match. Requires customer match approval.
- Upholstered products offered for graded-in fabric selections.

- All list prices are FOB: Factory Goshen, IN USA
- All product dimensions are shown in INCHES
- For finish options [SEE PAGE 82](#)

SIXINCH™ USA / 901 East Madison / Goshen, IN 46528 USA / (855) 577-2417 / support@sixinch.us / sixinchusa.com

REMINDER: Void if printed. Remember to double-check pricing from current price list on SIXINCH website <https://sixinchusa.com/price-list>

DUCK

Designed by SIXINCH® USA

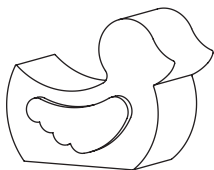

Model: Duck
Weight: Approx 25 lbs.
Base UPH: Wood w/Plastic Glides
Base Coated: FlexPlus™ Coated Wood
Glides: Plastic (Black)
Material: Foam
Finish: FlexPlus™ Coated or Upholstered

Dimensions: **FlexPlus List Price \$1,050**

W: 12
 D: 24
 H: 20
 SH: 20

Upgrades
[Add to List Price](#)

+\$225 Casters (add 1.2" to overall height)

Duck - Upholstered	Yardage	COM	A	B	C	D	E	F	G	H	I
	2	\$596	\$663	\$696	\$743	\$789	\$836	\$903	\$969	\$1,094	\$1,200

FOX

Designed by SIXINCH® USA

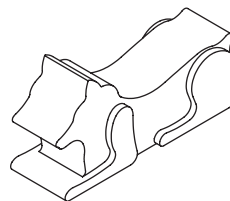

Model: Pig
Weight: Approx 25 lbs.
Base UPH: Wood w/Plastic Glides
Base Coated: FlexPlus™ Coated Wood
Glides: Plastic (Black)
Material: Foam
Finish: FlexPlus™ Coated or Upholstered

Dimensions: **FlexPlus List Price \$1,200**

W: 10.5
 D: 32.5
 H: 16.5
 SH: 16.5

Upgrades
[Add to List Price](#)

+\$225 Casters (add 1.2" to overall height)

Fox - Upholstered	Yardage	COM	A	B	C	D	E	F	G	H	I
	2.25	\$719	\$794	\$831	\$884	\$936	\$989	\$1,064	\$1,139	\$1,279	\$1,399

ELEPHANT

Designed by SIXINCH® USA

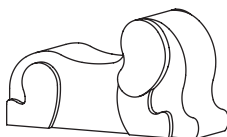

Model: Elephant
Weight: Approx 25 lbs.
Base UPH: Wood w/Plastic Glides
Base Coated: FlexPlus™ Coated Wood
Glides: Plastic (Black)
Material: Foam
Finish: FlexPlus™ Coated or Upholstered

Dimensions: **FlexPlus List Price \$1,600**

W: 13.5
 D: 35
 H: 20
 SH: 20

Upgrades
[Add to List Price](#)

+\$225 Casters (add 1.2" to overall height)

Elephant - Upholstered	Yardage	COM	A	B	C	D	E	F	G	H	I
	2	\$783	\$850	\$883	\$930	\$976	\$1,023	\$1,090	\$1,156	\$1,281	\$1,387

PIG

Designed by SIXINCH® USA

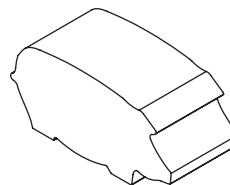

Model: Pig
Weight: Approx 18 lbs.
Base UPH: Wood w/Plastic Glides
Base Coated: FlexPlus™ Coated Wood
Glides: Plastic (Black)
Material: Foam
Finish: FlexPlus™ Coated or Upholstered

Dimensions: **FlexPlus List Price \$1,050**

W: 10
 D: 28.5
 H: 12.5
 SH: 12.5

Upgrades
[Add to List Price](#)

+\$225 Casters (add 1.2" to overall height)

Pig - Upholstered	Yardage	COM	A	B	C	D	E	F	G	H	I
	1.75	\$552	\$610	\$639	\$680	\$721	\$762	\$820	\$879	\$987	\$1,081

PIGLET

Designed by SIXINCH® USA

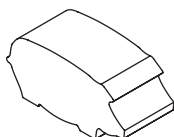

Model: Pig
Weight: Approx 15 lbs.
Base UPH: Wood w/Plastic Glides
Base Coated: FlexPlus™ Coated Wood
Glides: Plastic (Black)
Material: Foam
Finish: FlexPlus™ Coated or Upholstered

Dimensions: **FlexPlus List Price \$940**

W: 10
 D: 23
 H: 11
 SH: 11

Upgrades
[Add to List Price](#)

+\$225 Casters (add 1.2" to overall height)

Piglet - Upholstered	Yardage	COM	A	B	C	D	E	F	G	H	I
	1.5	\$530	\$580	\$605	\$640	\$675	\$710	\$760	\$810	\$903	\$983

SHARK

Designed by SIXINCH® USA



Model: Pig
Weight: Approx 25 lbs.
Base UPH: Wood w/Plastic Glides
Base Coated: FlexPlus™ Coated Wood
Glides: Plastic (Black)
Material: Foam
Finish: FlexPlus™ Coated or Upholstered

Dimensions: **FlexPlus List Price \$1,200**

W: 14
 D: 34.5
 H: 17
 SH: 17

Upgrades
[Add to List Price](#)

+\$225 Casters (add 1.2" to overall height)

Shark - Upholstered	Yardage	COM	A	B	C	D	E	F	G	H	I
	2.25	\$640	\$715	\$752	\$805	\$857	\$910	\$985	\$1,060	\$1,200	\$1,320

S1-0

Designed by SIXINCH® Design

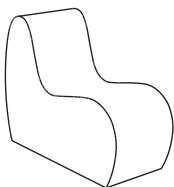

Model: S1-0
Weight: Approx
Base UPH: Wood w/Plastic Glides
Base Coated: FlexPlus™ Coated Wood
Glides: Plastic (Black)
Material: Foam
Finish: FlexPlus™ Coated or Upholstered

Dimensions: **FlexPlus List Price \$2,500**
W: 18
D: 37
H: 29.5
SH: 18
SD: 24.5

S1-0 - Upholstered	Yardage	COM	A	B	C	D	E	F	G	H	I
	3	\$1,122	\$1,222	\$1,272	\$1,342	\$1,402	\$1,482	\$1,582	\$1,682	\$1,869	\$2,029

S1-2

Designed by SIXINCH® Design

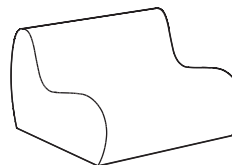

Model: S1-2
Weight: Approx
Base UPH: Wood w/Plastic Glides
Base Coated: FlexPlus™ Coated Wood
Glides: Plastic (Black)
Material: Foam
Finish: FlexPlus™ Coated or Upholstered

Dimensions: **FlexPlus List Price \$5,105**
W: 47.5
D: 37
H: 29.5
SH: 18
SD: 24.5

S1-2 - Upholstered	Yardage	COM	A	B	C	D	E	F	G	H	I
	5	\$2,010	\$2,177	\$2,260	\$2,377	\$2,477	\$2,610	\$2,777	\$2,943	\$3,254	\$3,521

S1-1

Designed by SIXINCH® Design

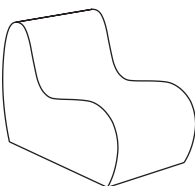

Model: S1-1
Weight: Approx 55 lbs.
Base UPH: Wood w/Plastic Glides
Base Coated: FlexPlus™ Coated Wood
Glides: Plastic (Black)
Material: Foam
Finish: FlexPlus™ Coated or Upholstered

Dimensions: **FlexPlus List Price \$2,830**
W: 24
D: 37
H: 29.5
SH: 18
SD: 24.5

S1-1 - Upholstered	Yardage	COM	A	B	C	D	E	F	G	H	I
	3	\$1,157	\$1,257	\$1,307	\$1,377	\$1,437	\$1,517	\$1,617	\$1,717	\$1,904	\$2,064

S1-3

Designed by SIXINCH® Design

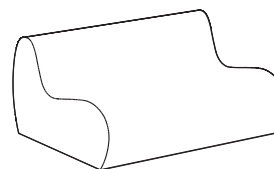

Model: S1-3
Weight: Approx
Base UPH: Wood w/Plastic Glides
Base Coated: FlexPlus™ Coated Wood
Glides: Plastic (Black)
Material: Foam
Finish: FlexPlus™ Coated or Upholstered

Dimensions: **FlexPlus List Price \$7,815**
W: 71
D: 37
H: 29.5
SH: 18
SD: 24.5

S1-3 - Upholstered	Yardage	COM	A	B	C	D	E	F	G	H	I
	6	\$2,961	\$3,161	\$3,261	\$3,401	\$3,521	\$3,681	\$3,881	\$4,081	\$4,454	\$4,774

S1-4

Designed by SIXINCH® Design

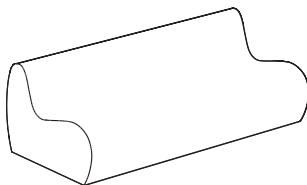

Model: S1-4
Weight: Approx 190 lbs.
Base UPH: Wood w/Plastic Glides
Base Coated: FlexPlus™ Coated Wood
Glides: Plastic (Black)
Material: Foam
Finish: FlexPlus™ Coated or Upholstered

Dimensions: **FlexPlus List Price - Call**
W: 94.5
D: 37
H: 29.5
SH: 18
SD: 24.5

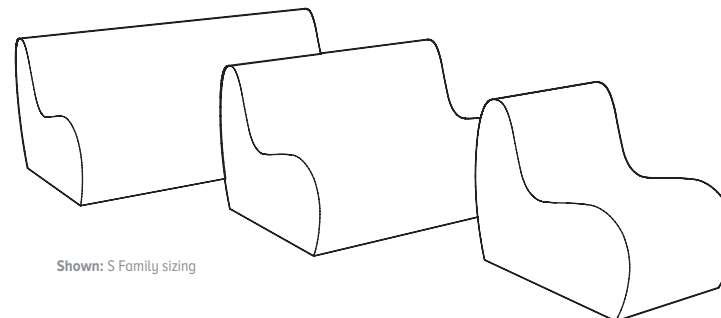

Shown: S Family sizing

S1-4 - Upholstered	Yardage	COM	A	B	C	D	E	F	G	H	I
	7	\$3,342	\$3,575	\$3,692	\$3,855	\$3,995	\$4,182	\$4,415	\$4,648	\$5,084	\$5,457

S1 ELEPHANT 1

Designed by SIXINCH® Design

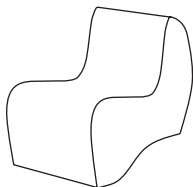

Model: S1 Elephant 1
Weight: Approx 55 lbs.
Base: FlexPlus™ Coated Wood
Glides: Plastic (Black)
Material: Foam
Finish: FlexPlus™ Coated

Dimensions: **FlexPlus List Price \$3,365**
W: 28
D: 37
H: 29.5
SH: 18
SD: 24.5

S1 ELEPHANT 3

Designed by SIXINCH® Design

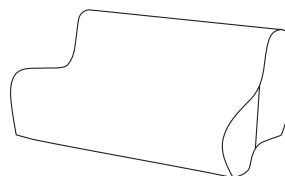

Model: S1 Elephant 3
Weight: Approx
Base: FlexPlus™ Coated Wood
Glides: Plastic (Black)
Material: Foam
Finish: FlexPlus™ Coated

Dimensions: **FlexPlus List Price \$7,815**
W: 71
D: 37
H: 29.5
SH: 18
SD: 24.5

S1 ELEPHANT 2

Designed by SIXINCH® Design

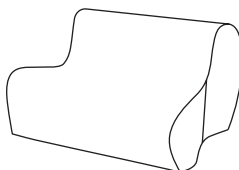

Model: S1 Elephant 2
Weight: Approx
Base: FlexPlus™ Coated Wood
Glides: Plastic (Black)
Material: Foam
Finish: FlexPlus™ Coated

Dimensions: **FlexPlus List Price \$5,450**
W: 47.5
D: 37
H: 29.5
SH: 18
SD: 24.5

S1 ELEPHANT 4

Designed by SIXINCH® Design

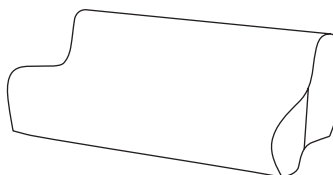

Model: S1 Elephant 4
Weight: Approx 190 lbs.
Base: FlexPlus™ Coated Wood
Glides: Plastic (Black)
Material: Foam
Finish: FlexPlus™ Coated

Dimensions: **FlexPlus List Price - Call**
W: 94.5
D: 37
H: 29.5
SH: 18
SD: 24.5

DIAMOND SEAT 0

Designed by SIXINCH® Design

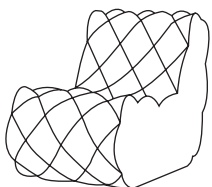

Model: Diamond Seat 0
Weight: Approx
Base: FlexPlus™ Coated Wood
Glides: Plastic (Black)
Material: Foam
Finish: FlexPlus™ Coated or Upholstered

Dimensions: **FlexPlus List Price \$3,160**
W: 18
D: 43.5
H: 27
SH: 14
SD: 27.5

DIAMOND SEAT 3

Designed by SIXINCH® Design

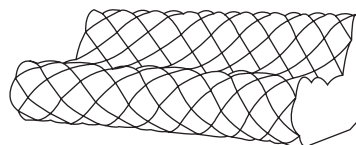

Model: Diamond Seat 3
Weight: Approx
Base: FlexPlus™ Coated Wood
Glides: Plastic (Black)
Material: Foam
Finish: FlexPlus™ Coated or Upholstered

Dimensions: **FlexPlus List Price \$12,825**
W: 81
D: 43.5
H: 27
SH: 14
SD: 27.5

DIAMOND SEAT 1

Designed by SIXINCH® Design

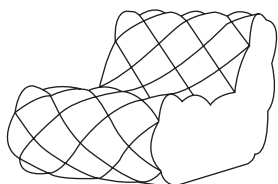

Model: Diamond Seat 1
Weight: Approx 65 lbs.
Base: FlexPlus™ Coated Wood
Glides: Plastic (Black)
Material: Foam
Finish: FlexPlus™ Coated or Upholstered

Dimensions: **FlexPlus List Price \$4,040**
W: 27
D: 43.5
H: 27
SH: 14
SD: 27.5

BENCH SOFA 1

Designed by SIXINCH® Design

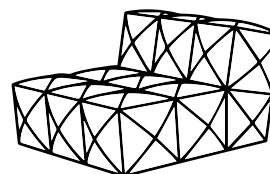

Model: Bench Sofa 1
Weight: Approx 75 lbs.
Base: FlexPlus™ Coated Wood
Glides: Plastic (Black)
Material: Foam
Finish: FlexPlus™ Coated

Dimensions: **FlexPlus List Price \$5,000**
W: 39
D: 41
H: 27.5
SH: 15
SD: 24.5

DIAMOND SEAT 2

Designed by SIXINCH® Design

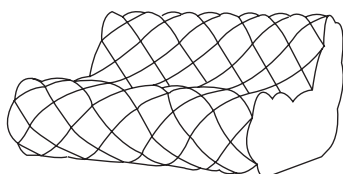

Model: Diamond Seat 2
Weight: Approx 160 lbs.
Base: FlexPlus™ Coated Wood
Glides: Plastic (Black)
Material: Foam
Finish: FlexPlus™ Coated or Upholstered

Dimensions: **FlexPlus List Price \$10,400**
W: 54
D: 43.5
H: 27
SH: 14
SD: 27.5

BENCH SOFA 2

Designed by SIXINCH® Design

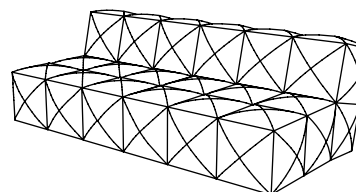

Model: Bench Sofa 2
Weight: Approx 140 lbs.
Base: FlexPlus™ Coated Wood
Glides: Plastic (Black)
Material: Foam
Finish: FlexPlus™ Coated

Dimensions: **FlexPlus List Price \$10,860**
W: 74
D: 41
H: 27.5
SH: 15
SD: 24.5

TRINITY 1

WRAPZ

Designed by SIXINCH® Design

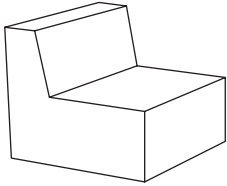

Model: Trinity 1
Weight: Approx
 Base UPH: Wood w/Plastic Glides
 Base Coated: FlexPlus™ Coated Wood
 Glides: Plastic (Black)
 Material: Foam
 Finish: FlexPlus™ Coated or Upholstered
 Quick Ship: FlexPlus™ Coated

Dimensions: FlexPlus List Price \$3,390

W: 31.5
 D: 31.5
 H: 28.5
 SH: 15.5
 SD: 21

Fabric Required:

Solid: 4ly
 Two-Tone: Zone A 1.5ly Zone B 2.5ly

Trinity 1	Yardage	COM	A	B	C	D	E	F	G	H	I
Upholstered (Solid)	4	\$1,345	\$1,478	\$1,545	\$1,638	\$1,732	\$1,825	\$1,958	\$2,092	\$2,340	\$2,554
Plush	4	\$1,532	\$1,665	\$1,732	\$1,825	\$1,919	\$2,012	\$2,145	\$2,279	\$2,527	\$2,741
Plush w/ plinth base	4	\$1,804	\$1,937	\$2,004	\$2,097	\$2,191	\$2,284	\$2,417	\$2,551	\$2,799	\$3,013

TRINITY 2

WRAPZ

Designed by SIXINCH® Design

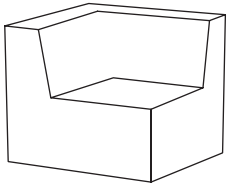

Model: Trinity 2
Weight: Approx
 Base UPH: Wood w/Plastic Glides
 Base Coated: FlexPlus™ Coated Wood
 Glides: Plastic (Black)
 Material: Foam
 Finish: FlexPlus™ Coated or Upholstered
 Quick Ship: FlexPlus™ Coated

Dimensions: FlexPlus List Price \$4,350

W: 31.5
 D: 31.5
 H: 28.5
 SH: 15.5
 SD: 21

Fabric Required:

Solid: 4ly
 Two-Tone: Zone A 1.5ly Zone B 3ly

Trinity 2 - Upholstered	Yardage	COM	A	B	C	D	E	F	G	H	I
Upholstered (Solid)	4	\$1,606	\$1,739	\$1,806	\$1,899	\$1,993	\$2,086	\$2,219	\$2,353	\$2,601	\$2,815
Plush	4.5	\$1,819	\$1,969	\$2,044	\$2,149	\$2,254	\$2,359	\$2,509	\$2,659	\$2,939	\$3,179
Plush w/ plinth base	4.5	\$2,092	\$2,242	\$2,317	\$2,422	\$2,527	\$2,632	\$2,782	\$2,932	\$3,212	\$3,452

TRINITY 3

WRAPZ

Designed by SIXINCH® Design

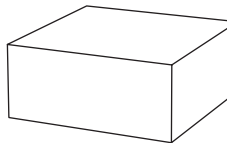

Model: Trinity 3
Weight: Approx
 Base UPH: Wood w/Plastic Glides
 Base Coated: FlexPlus™ Coated Wood
 Glides: Plastic (Black)
 Material: Foam
 Finish: FlexPlus™ Coated or Upholstered

Dimensions: FlexPlus List Price \$2,470

W: 31.5
 D: 31.5
 H: 15.5
 SH: 15.5

Fabric Required:

Solid: 3ly
 Two-Tone: Zone A 1.5ly Zone B 2ly

Trinity 3 - Upholstered	Yardage	COM	A	B	C	D	E	F	G	H	I
Upholstered (Solid)	3	\$1,082	\$1,182	\$1,232	\$1,302	\$1,372	\$1,442	\$1,542	\$1,642	\$1,829	\$1,989
Plush	3.5	\$1,234	\$1,351	\$1,409	\$1,491	\$1,572	\$1,654	\$1,771	\$1,887	\$2,105	\$2,292
Plush w/ plinth base	3.5	\$1,506	\$1,623	\$1,681	\$1,763	\$1,844	\$1,926	\$2,043	\$2,159	\$2,377	\$2,564

TRINITY 4

Designed by SIXINCH® Design

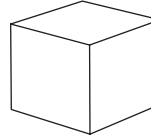

Model: Trinity 4
Weight: Approx
 Base UPH: Wood w/Plastic Glides
 Base Coated: FlexPlus™ Coated Wood
 Glides: Plastic (Black)
 Material: Foam
 Finish: FlexPlus™ Coated or Upholstered

Dimensions: FlexPlus List Price \$890

W: 16
 D: 16
 H: 15.5
 SH: 15.5

Trinity 4 - Upholstered	Yardage	COM	A	B	C	D	E	F	G	H	I
Upholstered (Solid)	1.5	\$614	\$664	\$689	\$724	\$759	\$794	\$844	\$894	\$987	\$1,067

TRINITY PLUSH ZONING

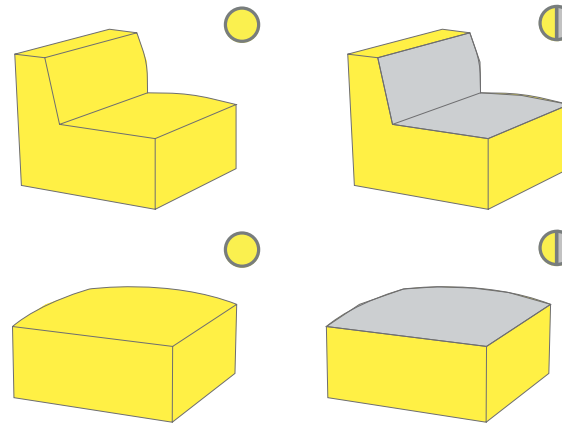

SOLID

Two-Tone

FABRIC 1

ZONE 1 - SIDES AND BACK

FABRIC 2

ZONE 2 - SEAT / BACK CUSHIONS

SOLID

Two-Tone

FABRIC 1

ZONE 1 - SIDES

FABRIC 2

ZONE 2 - CUSHION

TRINITY PLUSH PATTERN MATCH

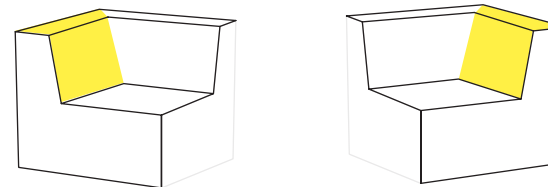

RIGHT HAND SIT

LEFT HAND SIT



Inventoried / Color and options limited
 Lead time varies 10-15 days - call for details

TRINITY JR 1

Designed by SIXINCH® Design

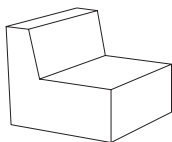

Model: Trinity Jr 1
Weight: Approx
Base: FlexPlus™ Coated Wood
Glides: Plastic (Black)
Material: Foam
Finish: FlexPlus™ Coated

Dimensions: **FlexPlus List Price \$1,990**
W: 24
D: 24
H: 25.5
SH: 12.75
SD: 16

TRINITY JR 4

Designed by SIXINCH® Design

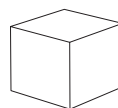

Model: Trinity Jr 4
Weight: Approx
Base: FlexPlus™ Coated Wood
Glides: Plastic (Black)
Material: Foam
Finish: FlexPlus™ Coated

Dimensions: **FlexPlus List Price \$750**
W: 16
D: 16
H: 12.75
SH: 12.75

TRINITY JR 2

Designed by SIXINCH® Design

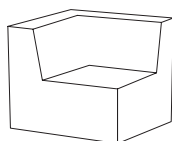

Model: Trinity Jr 2
Weight: Approx
Base: FlexPlus™ Coated Wood
Glides: Plastic (Black)
Material: Foam
Finish: FlexPlus™ Coated

Dimensions: **FlexPlus List Price \$2,100**
W: 24
D: 24
H: 25.5
SH: 12.75
SD: 16

TRINITY - GANGING

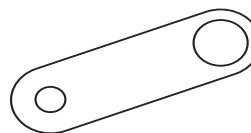

Model: Upholstered Trinity
SKU: SXY-GANG-01
Weight: Approx 1 lbs.
Material: HDPE
Color: Black

List Price \$115
 *Sold in packs of (4)

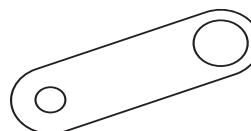

Model: FlexPlus Trinity
SKU: SXY-GANG-02
Weight: Approx 1 lbs.
Material: HDPE
Color: Black

List Price \$115
 *Sold in packs of (4)

TRINITY JR 3

Designed by SIXINCH® Design

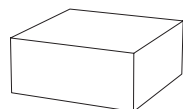

Model: Trinity Jr 3
Weight: Approx
Base: FlexPlus™ Coated Wood
Glides: Plastic (Black)
Material: Foam
Finish: FlexPlus™ Coated

Dimensions: **FlexPlus List Price \$1,400**
W: 24
D: 24
H: 12.75
SH: 12.75

ROCK ELEMENTS 1



Designed by Rainer Mutsch

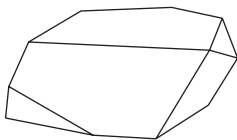

Model: Rock Element 1
Weight: Approx
Base: FlexPlus™ Coated Wood
Glides: Plastic (Black)
Material: Foam
Finish: FlexPlus™ Coated
Quick Ship: FlexPlus™ Coated

Dimensions: **FlexPlus List Price \$1,375**
W: 31
D: 17.5
H: 14.5
SH: 14.5

ROCK ELEMENTS 5

Designed by Rainer Mutsch

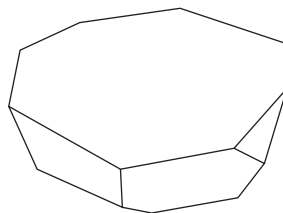

Model: Rock Element 5
Weight: Approx
Base: FlexPlus™ Coated Wood
Glides: Plastic (Black)
Material: Foam
Finish: FlexPlus™ Coated

Dimensions: **FlexPlus List Price \$7,610**
W: 49
D: 49
H: 13.5
SH: 13.5

ROCK ELEMENTS 2



Designed by Rainer Mutsch

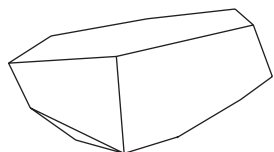

Model: Rock Element 2
Weight: Approx 30 lbs.
Base: FlexPlus™ Coated Wood
Glides: Plastic (Black)
Material: Foam
Finish: FlexPlus™ Coated
Quick Ship: FlexPlus™ Coated

Dimensions: **FlexPlus List Price \$1,665**
W: 39
D: 17.5
H: 15.5
SH: 15.5

ROCK ELEMENTS 6

Designed by Rainer Mutsch

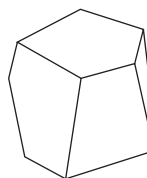

Model: Rock Element 6
Weight: Approx
Base: FlexPlus™ Coated Wood
Glides: Plastic (Black)
Material: Foam
Finish: FlexPlus™ Coated

Dimensions: **FlexPlus List Price \$1,340**
W: 19
D: 18
H: 18
SH: 18

ROCK ELEMENTS 3

Designed by Rainer Mutsch

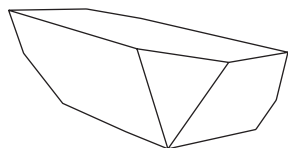

Model: Rock Element 3
Weight: Approx
Base: FlexPlus™ Coated Wood
Glides: Plastic (Black)
Material: Foam
Finish: FlexPlus™ Coated

Dimensions: **FlexPlus List Price \$2,300**
W: 47
D: 20
H: 16.5
SH: 17.5

ROCK ELEMENTS 4

Designed by Rainer Mutsch

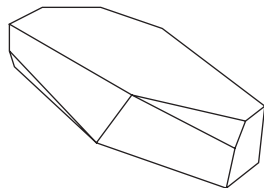

Model: Rock Element 4
Weight: Approx
Base: FlexPlus™ Coated Wood
Glides: Plastic (Black)
Material: Foam
Finish: FlexPlus™ Coated

Dimensions: **FlexPlus List Price \$3,975**
W: 61
D: 23
H: 17
SH: 17

SPLIT BENCH

Designed by SIXINCH® USA

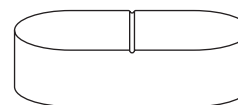

Model: Split Bench
Weight: Approx 75 lbs.
Base UPH: Wood w/Glides
Base Coated: FlexPlus™ Coated Wood w/Glides
Glides: Plastic (Black)
Material: Foam
Finish: FlexPlus™ Coated or Upholstered

Dimensions: **FlexPlus List Price \$5,855**
W: 32
D: 63
H: 17
SH: 17

Split Bench - Upholstered	Yardage	COM	A	B	C	D	E	F	G	H	I
	3.5	\$1,638	\$1,755	\$1,813	\$1,895	\$1,965	\$2,058	\$2,175	\$2,291	\$2,509	\$2,696



Inventoried / Color and options limited
 Lead time varies 10-15 days - call for details

- List prices for FlexPlus™ coated products includes standard colors.
- Custom FlexPlus coating colors add \$500 net price per color match. Requires customer match approval.
- Upholstered products offered for graded-in fabric selections.

- All list prices are FOB: Factory Goshen, IN USA
- All product dimensions are shown in INCHES
- For finish options [SEE PAGE 82](#)

SIXINCH™ USA / 901 East Madison / Goshen, IN 46528 USA / (855) 577-2417 / support@sixinch.us / sixinchusa.com

REMINDER: Void if printed. Remember to double-check pricing from current price list on SIXINCH website <https://sixinchusa.com/price-list>

LOUIS 1

Designed by SIXINCH® Design

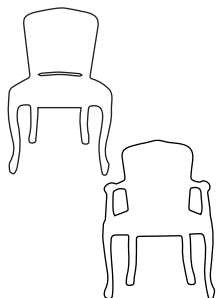

Model: Louis Armless
Weight: Approx 44 lbs.
Shell: FlexPlus™ Coated Wood
Material: Upholstered Foam, Wood
Finish: FlexPlus™ Coated

Dimensions: **FlexPlus List Price \$4,522**

W: 19
 D: 19.5
 H: 37
 SH: 20

Model: Louis Arm
Weight: Approx 45 lbs.
Shell: FlexPlus™ Coated Wood
Material: Upholstered Foam, Wood
Finish: FlexPlus™ Coated

Dimensions: **FlexPlus List Price \$5,490**

W: 23.5
 D: 19.5
 H: 37
 SH: 20

LOUIS 2 ARMCHAIR

Designed by SIXINCH® Design

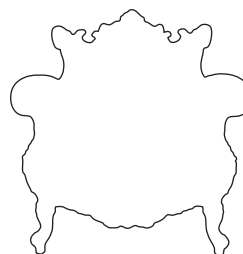

Model: Louis Armless
Weight: Approx
Shell: FlexPlus™ Coated Wood
Material: Upholstered Foam, Wood
Finish: FlexPlus™ Coated

Dimensions: **FlexPlus List Price \$21,613**

W: 37.5
 D: 30.5
 H: 44.5
 SH: 20.5

LOUIS 1b

Designed by SIXINCH® Design

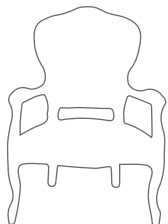

Model: Louis 1b
Weight: Approx 60 lbs.
Shell: FlexPlus™ Coated Wood
Material: Upholstered Foam, Wood
Finish: FlexPlus™ Coated

Dimensions: **FlexPlus List Price \$5,490**

W: 26
 D: 29
 H: 43.5
 SH: 16.5

LOUIS 2 LOVESEAT

Designed by SIXINCH® Design

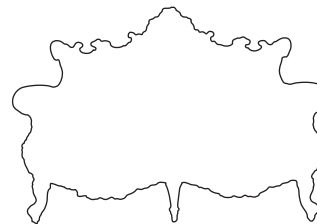

Model: Louis 2 Loveseat
Weight: Approx 150 lbs.
Shell: FlexPlus™ Coated Wood
Material: Upholstered Foam, Wood
Finish: FlexPlus™ Coated

Dimensions: **FlexPlus List Price \$30,815**

W: 55.5
 D: 30.5
 H: 47.5
 SH: 20.5

LOUIS BARSTOOL

Designed by SIXINCH® Design

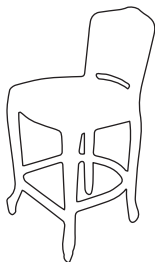

Model: Louis Barstool
Weight: Approx 40 lbs.
Shell: FlexPlus™ Coated Wood
Material: Upholstered Foam, Wood
Finish: FlexPlus™ Coated

Dimensions: **FlexPlus List Price \$5,654**

W: 18
 D: 19
 H: 42
 SH: 29

LOUIS 3 SOFA

Designed by SIXINCH® Design

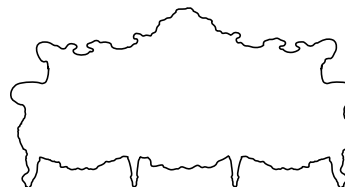

Model: Louis 3 Sofa
Weight: Approx 225 lbs.
Shell: FlexPlus™ Coated Wood
Material: Upholstered Foam, Wood
Finish: FlexPlus™ Coated

Dimensions: **FlexPlus List Price \$46,618**

W: 80
 D: 30.5
 H: 48.5
 SH: 20.5

Import / 12-14 Week Lead Time

BEAST 1

Designed by SIXINCH® Design

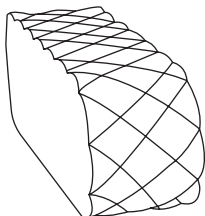

Model: Beast 1
Weight: Approx
Base: FlexPlus™ Coated Wood
Glides: Plastic (Black)
Material: Foam
Finish: FlexPlus™ Coated

Dimensions: **FlexPlus List Price \$3,425**
W: 14
D: 55
H: 19
SH: 20.5

BEAST 4

Designed by SIXINCH® Design

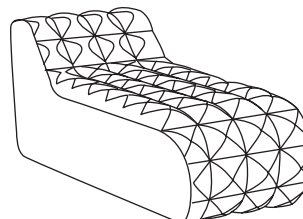

Model: Beast 4
Weight: Approx
Base: FlexPlus™ Coated Wood
Glides: Plastic (Black)
Material: Foam
Finish: FlexPlus™ Coated

Dimensions: **FlexPlus List Price \$6,525**
W: 26
D: 52
H: 31.5
SH: 20.5

BEAST 2

Designed by SIXINCH® Design

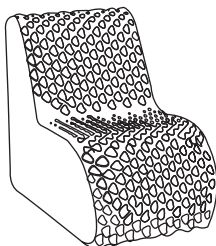

Model: Beast 2
Weight: Approx
Base: FlexPlus™ Coated Wood
Glides: Plastic (Black)
Material: Foam
Finish: FlexPlus™ Coated

Dimensions: **FlexPlus List Price \$5,705**
W: 22
D: 47.5
H: 33.5
SH: 20.5

BEAST 5

Designed by SIXINCH® Design

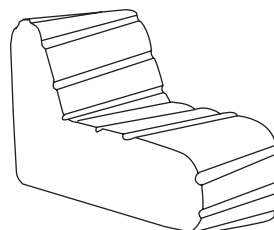

Model: Beast 5
Weight: Approx
Base: FlexPlus™ Coated Wood
Glides: Plastic (Black)
Material: Foam
Finish: FlexPlus™ Coated

Dimensions: **FlexPlus List Price \$6,375**
W: 26
D: 52
H: 31.5
SH: 20.5

BEAST 3

Designed by SIXINCH® Design

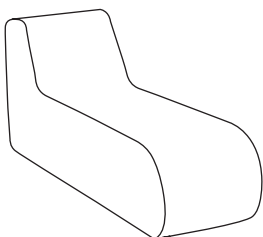

Model: Beast 3
Weight: Approx
Base: FlexPlus™ Coated Wood
Glides: Plastic (Black)
Material: Foam
Finish: FlexPlus™ Coated

Dimensions: **FlexPlus List Price \$5,040**
W: 18
D: 70
H: 30.5
SH: 20.5

BEAST 6

Designed by SIXINCH® Design

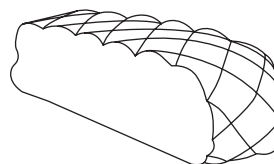

Model: Beast 6
Weight: Approx
Base: FlexPlus™ Coated Wood
Glides: Plastic (Black)
Material: Foam
Finish: FlexPlus™ Coated

Dimensions: **FlexPlus List Price \$3,365**
W: 18
D: 47
H: 31.5
SH: 20.5

BEAST 7

Designed by SIXINCH® Design

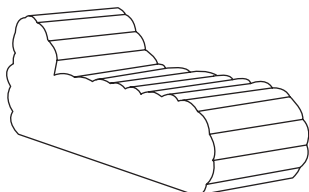

Model: Beast 7
Weight: Approx
Base: FlexPlus™ Coated Wood
Glides: Plastic (Black)
Material: Foam
Finish: FlexPlus™ Coated

Dimensions: **FlexPlus List Price \$4,925**
W: 22
D: 59.5
H: 26
SH: 20.5

BEAST 8

Designed by SIXINCH® Design

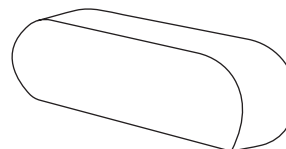

Model: Beast 8
Weight: Approx
Base: FlexPlus™ Coated Wood
Glides: Plastic (Black)
Material: Foam
Finish: FlexPlus™ Coated

Dimensions: **FlexPlus List Price \$3,280**
W: 14
D: 53
H: 18.5
SH: 20.5

BEAST - COMPLETE

Designed by SIXINCH® Design

Model: Beast Complete
Weight: Approx
Base: FlexPlus™ Coated Wood
Glides: Plastic (Black)
Material: Foam
Finish: FlexPlus™ Coated

Dimensions: **FlexPlus List Price \$38,630**
W: 155.5
D: 70
H: 36.5
SH: 20.5

*Produced as (8) individual units

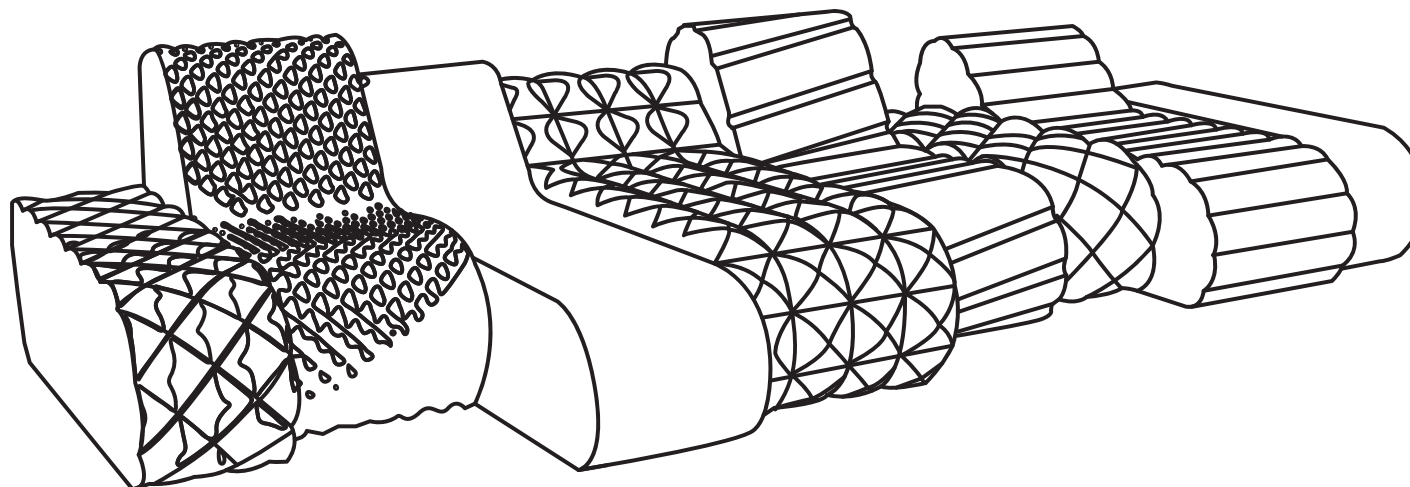

CLIFFY POUF

Designed by Rainer Mutsch

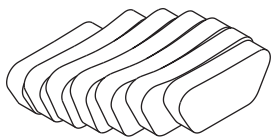

Model: Cliffy Pouf
Weight: Approx 60 lbs.
Base: FlexPlus™ Coated Wood
Glides: Plastic (Black)
Material: Foam
Finish: FlexPlus™ Coated

Dimensions: FlexPlus List Price \$3,170
W: 33.5
D: 46
H: 16.5
SH: 16.5

CLIFFY 2000

Designed by Rainer Mutsch

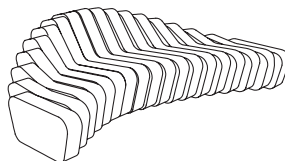

Model: Cliffy 2000
Weight: Approx 250 lbs.
Base: FlexPlus™ Coated Wood
Glides: Plastic (Black)
Material: Foam
Finish: FlexPlus™ Coated

Dimensions: FlexPlus List Price \$9,365
W: 85.5
D: 60
H: 28
SH: 17
SD: 22.5

*Produced as (1) single unit

CLIFFY 360

Designed by Rainer Mutsch

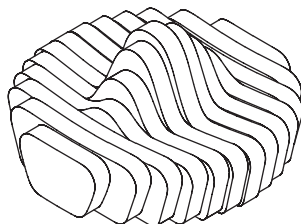

Model: Cliffy 360
Weight: Approx 270 lbs.
Base: FlexPlus™ Coated Wood
Glides: Plastic (Black)
Material: Foam
Finish: FlexPlus™ Coated

Dimensions: FlexPlus List Price \$9,710
W: 63.5
D: 61.5
H: 34.5
SH: 17
SD: 22.5

CLIFFY 4000

Designed by Rainer Mutsch

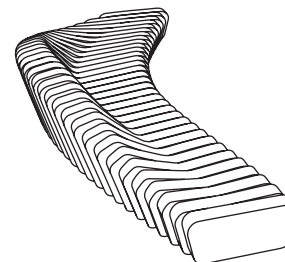

Model: Cliffy 4000
Weight: Approx 600 lbs.
Base: FlexPlus™ Coated Wood
Glides: Plastic (Black)
Material: Foam
Finish: FlexPlus™ Coated

Dimensions: FlexPlus List Price \$20,640
W: 161
D: 70
H: 29.5
SH: 17
SD: 22.5

*Produced as (2) individual units

CLIFFY 1000

Designed by Rainer Mutsch

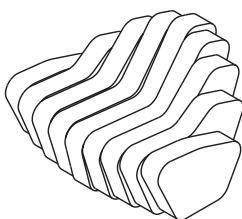

Model: Cliffy 1000
Weight: Approx 94 lbs.
Base: FlexPlus™ Coated Wood
Glides: Plastic (Black)
Material: Foam
Finish: FlexPlus™ Coated

Dimensions: FlexPlus List Price \$4,380
W: 43
D: 37.5
H: 28
SH: 17
SD: 22.5

CLIFFY 6000

Designed by Rainer Mutsch

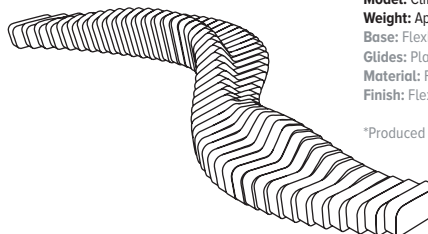

Model: Cliffy 6000
Weight: Approx 900 lbs.
Base: FlexPlus™ Coated Wood
Glides: Plastic (Black)
Material: Foam
Finish: FlexPlus™ Coated

Dimensions: FlexPlus List Price \$29,065
W: 238
D: 102.5
H: 28.5
SH: 17
SD: 22.5

*Produced as (3) individual units

RIVER MUST FLOW 1

Designed by Karim Rashid

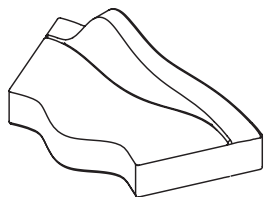

Model: River Must Flow 1
Weight: Approx 275 lbs.
Base: FlexPlus™ Coated Wood
Glides: Black Adjustable Glides
Material: Foam
Finish: FlexPlus™ Coated

Dimensions: **FlexPlus List Price \$12,000**
W: 81
D: 41
H: 26
SH: 12

CIRCLE LOUNGE

Designed by SIXINCH® Design



Model: Circle Lounge
Weight: Approx 110 lbs.
Base: FlexPlus™ Coated Wood
Glides: Plastic (Black)
Material: Foam
Finish: FlexPlus™ Coated

Dimensions: **FlexPlus List Price \$6,000**
W: 49.5
D: 49.5
H: 24
SH: 15
SD: 25

RIVER MUST FLOW 2

Designed by Karim Rashid

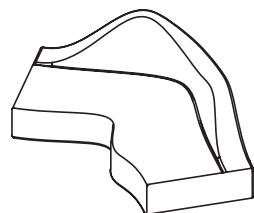

Model: River Must Flow 2
Weight: Approx 275 lbs.
Base: FlexPlus™ Coated Wood
Glides: Black Adjustable Glides
Material: Foam
Finish: FlexPlus™ Coated

Dimensions: **FlexPlus List Price \$22,500**
W: 101
D: 62
H: 32
SH: 12

LOUNGE S

Designed by SIXINCH® Design

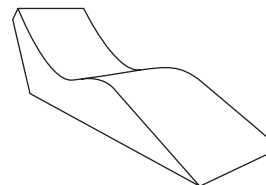

Model: Lounge S
Weight: Approx 90 lbs.
Base: FlexPlus™ Coated Wood
Glides: Plastic (Black)
Material: Foam
Finish: FlexPlus™ Coated

Dimensions: **FlexPlus List Price \$5,478**
W: 76.5
D: 22
H: 24.5
SH: 15
SD: 15

RIVER MUST FLOW 3

Designed by Karim Rashid

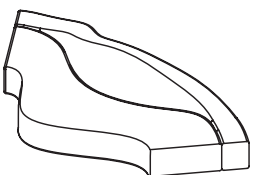

Model: River Must Flow 3
Weight: Approx 275 lbs.
Base: FlexPlus™ Coated Wood
Glides: Black Adjustable Glides
Material: Foam
Finish: FlexPlus™ Coated

Dimensions: **FlexPlus List Price \$21,750**
W: 120
D: 58
H: 30
SH: 12

CUBIK LOUNGE

Designed by SIXINCH® USA

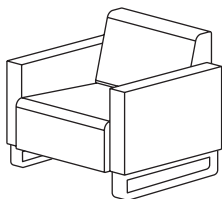

Model: Cubik Lounge
Weight: Approx 65 lbs.
Leg Type: Sled Metal or Wood
Leg Finish: Powder Coated Metal or Stained Wood
Material: Upholstered Foam
Zoning: Solid, Two-Tone
Quilting: Yes, Zone A (Page 58)

Dimensions:
W: 32
D: 29.5
H: 29.5
SH: 17.5
SD: 20.5

Upgrades
[Add to List Price](#)
+\$300 Quilting (Zone A)

Fabric Required:
• **Solid:** 4ly
• **Two-Tone:** Zone A 3ly Zone B 3ly

Cubik Lounge	Yardage	COM	A	B	C	D	E	F	G	H	I
Solid	4	\$2,796	\$2,929	\$2,996	\$3,089	\$3,183	\$3,276	\$3,409	\$3,543	\$3,791	\$4,005
Two-Tone	6	\$2,886	\$3,086	\$3,186	\$3,326	\$3,466	\$3,606	\$3,806	\$4,006	\$4,379	\$4,699

*If the textiles used in multi-zoning are different grades, use price of the higher grade level.

CUBIK SOFA

Designed by SIXINCH® USA

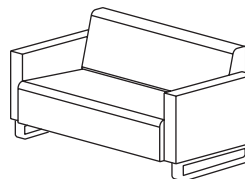

Model: Cubik Sofa
Weight: Approx 175 lbs.
Leg Type: Sled Metal or Wood
Leg Finish: Powder Coated Metal or Stained Wood
Material: Upholstered Foam
Zoning: Solid, Two-Tone
Quilting: Yes, Zone A (Page 58)

Dimensions:
W: 80
D: 29.5
H: 29.5
SH: 17.5
SD: 20.5

Upgrades
[Add to List Price](#)
+\$600 Quilting (Zone A)

Fabric Required:
• **Solid:** 6ly
• **Two-Tone:** Zone A 3ly Zone B 5ly

Cubik Sofa	Yardage	COM	A	B	C	D	E	F	G	H	I
Solid	6	\$3,940	\$4,140	\$4,240	\$4,380	\$4,520	\$4,660	\$4,860	\$5,060	\$5,433	\$5,753
Two-Tone	8	\$4,043	\$4,309	\$4,443	\$4,629	\$4,816	\$5,003	\$5,269	\$5,536	\$6,034	\$6,460

*If the textiles used in multi-zoning are different grades, use price of the higher grade level.

CUBIK SETTEE

Designed by SIXINCH® USA

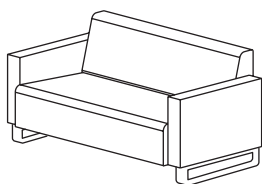

Model: Cubik Settee
Weight: Approx 140 lbs.
Leg Type: Sled Metal or Wood
Leg Finish: Powder Coated Metal or Stained Wood
Material: Upholstered Foam
Zoning: Solid, Two-Tone
Quilting: Yes, Zone A (Page 58)

Dimensions:
W: 56
D: 29.5
H: 29.5
SH: 17.5
SD: 20.5

Upgrades
[Add to List Price](#)
+\$500 Quilting (Zone A)

Fabric Required:
• **Solid:** 5ly
• **Two-Tone:** Zone A 3ly Zone B 4ly

Cubik Settee	Yardage	COM	A	B	C	D	E	F	G	H	I
Solid	5	\$3,447	\$3,614	\$3,697	\$3,814	\$3,930	\$4,047	\$4,214	\$4,380	\$4,691	\$4,958
Two-Tone	7	\$3,545	\$3,778	\$3,895	\$4,058	\$4,221	\$4,385	\$4,618	\$4,851	\$5,287	\$5,660

*If the textiles used in multi-zoning are different grades, use price of the higher grade level.

CUBIK OTTOMAN

Designed by SIXINCH® USA

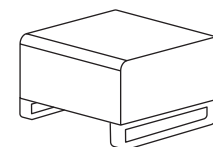

Model: Cubik Ottoman
Weight: Approx 28 lbs.
Leg Type: Sled Metal or Wood
Leg Finish: Powder Coated Metal or Stained Wood
Material: Upholstered Foam
Zoning: Solid
Quilting: Yes, Zone A (Page 58)

Dimensions:
W: 24
D: 24
H: 17.5
SH: 17.5

Upgrades
[Add to List Price](#)
+\$300 Quilting (Zone A)

Fabric Required:
• **Solid:** 2ly

Cubik Ottoman	Yardage	COM	A	B	C	D	E	F	G	H	I
Solid	2	\$1,754	\$1,821	\$1,854	\$1,901	\$1,947	\$1,994	\$2,061	\$2,127	\$2,252	\$2,358

*If the textiles used in multi-zoning are different grades, use price of the higher grade level.

CUBIK BENCH 56"

Designed by SIXINCH® USA

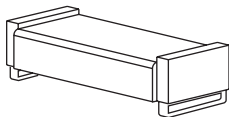

Model: Cubik Bench 56"
Weight: Approx 65 lbs.
Leg Type: Sled Metal or Wood
Leg Finish: Powder Coated Metal or Stained Wood
Material: Upholstered Foam
Zoning: Solid, Two-Tone
Quilting: Yes, Zone A (Page 58)

Dimensions:
W: 56
D: 24
H: 20
SH: 17.5
SD: 24

Upgrades
[Add to List Price](#)
+\$500 Quilting (Zone A)

Fabric Required:
• **Solid:** 3ly
• **Two-Tone:** Zone A 2ly Zone B 3ly

Cubik Bench 56"	Yardage	COM	A	B	C	D	E	F	G	H	I
Solid	3	\$2,423	\$2,523	\$2,573	\$2,643	\$2,713	\$2,783	\$2,883	\$2,983	\$3,170	\$3,330
Two-Tone	5	\$2,511	\$2,678	\$2,761	\$2,878	\$2,994	\$3,111	\$3,278	\$3,444	\$3,755	\$4,022

*If the textiles used in multi-zoning are different grades, use price of the higher grade level.

CUBIK BENCH 80"

Designed by SIXINCH® USA

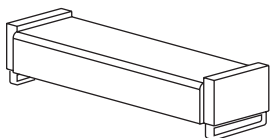

Model: Cubik Bench 80"
Weight: Approx
Leg Type: Sled Metal or Wood
Leg Finish: Powder Coated Metal or Stained Wood
Material: Upholstered Foam
Zoning: Solid, Two-Tone
Quilting: Yes, Zone A (Page 58)

Dimensions:
W: 80
D: 24
H: 20
SH: 17.5
SD: 24

Upgrades
[Add to List Price](#)
+\$600 Quilting (Zone A)

Fabric Required:
• **Solid:** 4ly
• **Two-Tone:** Zone A 2ly Zone B 3ly

Cubik Bench 80"	Yardage	COM	A	B	C	D	E	F	G	H	I
Solid	4	\$2,859	\$2,992	\$3,059	\$3,152	\$3,246	\$3,339	\$3,472	\$3,606	\$3,854	\$4,068
Two-Tone	5	\$2,926	\$3,093	\$3,176	\$3,293	\$3,409	\$3,526	\$3,693	\$3,859	\$4,170	\$4,437

*If the textiles used in multi-zoning are different grades, use price of the higher grade level.

CUBIK ZONING

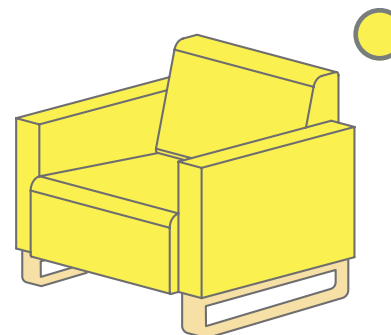

SOLID

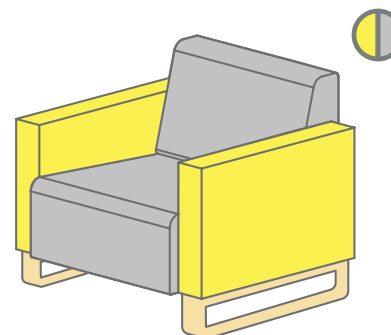

Two-Tone
FABRIC 1
ZONE A - BACK AND SEAT
FABRIC 2
ZONE B - ARMS

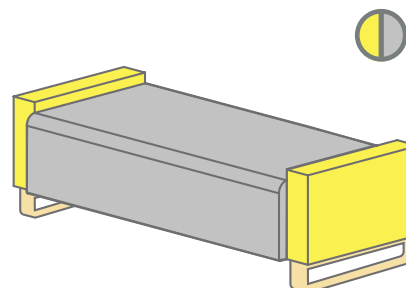

SOLID

Two-Tone
FABRIC 1
ZONE A - SEAT
FABRIC 2
ZONE B - SIDES

ALMG

Designed by Peter Maes



Model: ALMG
Weight: Approx 80 lbs.
Shell: Al Mg Alloy
Base: Steel
Finish: Powder Coated
Seat: Upholstered Foam
Zoning: Solid

Dimensions:
W: 27
D: 28
H: 28
SH: 11
SD: 17.5

ALMG	Yardage	COM	A	B	C	D	E	F	G	H	I
	2	\$3,750	\$3,817	\$3,850	\$3,897	\$3,943	\$3,990	\$4,057	\$4,123	\$4,248	\$4,354

TUBULAR

Designed by POPULOUS

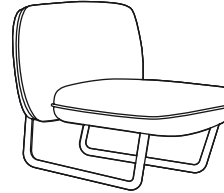

Model: Tubular
Weight: Approx 52 lbs.
Shell: Wood
Base: Bent Tube
Base Finish: Powder Coated
Seat: Upholstered Foam
Zoning: Solid, Seat/Back+Welt

Dimensions:
W: 37.5
D: 34
H: 34
SH: 19
SD: 23.5

Fabric Required:
• Solid: 4ly
• Two-Tone: Zone A (Seat/Back) 3.5ly Zone B (Welt) .5ly

Tubular	Yardage	COM	A	B	C	D	E	F	G	H	I
Textile	4	\$2,830	\$2,963	\$3,030	\$3,123	\$3,203	\$3,310	\$3,443	\$3,577	\$3,825	\$4,039
Leather	4	\$3,281	\$3,414	\$3,481	\$3,574	\$3,668	\$3,761	\$3,894	\$4,028	\$4,276	\$4,490

ALMG TABLE

Designed by Peter Maes

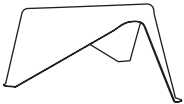

Model: ALMG Table
Weight: Approx 30 lbs.
Material: Steel
Finish: Powder Coated
Options: Indoor/Outdoor

Dimensions:
W: 32
D: 32
H: 14

List Price \$1,850

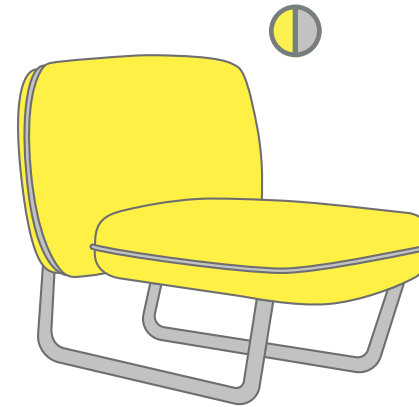

SOLID

TWO TONE
FABRIC 1
SEAT+BACK
FABRIC 2
WELT ACCENT

SOLE

Designed by POPULOUS



Model: Sole
Weight: Approx 40 lbs.
Shell: Wood
Seat: Upholstered Foam
Base: Bent Tube
Finish Metal: Powder Coated
Zoning: Solid, Shell+Seat, Shell+Seat+Heel Cup

Dimensions:
W: 28
D: 26
H: 29
SH: 19
SD: 20

Fabric Required:

- Solid 3.5ly
- Two-Tone: Zone A (Shell) 2.25ly Zone B (Seat) 1ly
- Three-Tone: Zone A (Shell) 2.25ly Zone B (Seat) 1ly Zone C (Heel Cup) 1ly

Sole - Upholstered	Yardage	COM	A	B	C	D	E	F	G	H	I
Sole Metal Tube	3.3	\$2,700	\$2,810	\$2,865	\$2,942	\$3,019	\$3,096	\$3,206	\$3,316	\$3,521	\$3,697

GNARLY HIGH BACK

Designed by SIXINCH® USA



Model: Gnarly High Back
Weight: Approx 90 lbs.
Shell: Wood
Base: Aluminum
Finish: Chrome
Seat: Upholstered Foam
Zoning: Solid, Seat/Back+Outter Shell

Dimensions:
W: 34
D: 31
H: 48
SH: 20
SD: 21

Fabric Required:

- Solid: 6.5ly
- Two-Tone: Zone A (Outter Shell) 3.5ly Zone B (Inside Cushions) 3.5ly

Gnarly High Back	Yardage	COM	A	B	C	D	E	F	G	H	I
Solid	6.5	\$3,181	\$3,397	\$3,506	\$3,657	\$3,788	\$3,961	\$4,177	\$4,394	\$4,799	\$5,145
Two-Tone	7	\$3,233	\$3,466	\$3,583	\$3,746	\$3,886	\$4,073	\$4,306	\$4,539	\$4,975	\$5,348

*If the textiles used in multi-zoning are different grades, use price of the higher grade level.



TWO TONE

FABRIC 1
BACK+HEEL ACCENT
FABRIC 2
SEAT



THREE TONE

FABRIC 1
BACK+HEEL
FABRIC 2
SEAT
FABRIC 3
HEEL ACCENT

GNARLY LOW BACK

WRAPZ

Designed by SIXINCH® USA



Model: Gnarly Low Back
Weight: Approx 75 lbs.
Shell: Wood
Base: Aluminum
Finish: Chrome
Seat: Upholstered Foam
Zoning: Solid, Seat/Back+Outter Shell

Dimensions:
W: 34
D: 31
H: 39.5
SH: 20
SD: 21

Fabric Required:

- Solid: 5.5ly
- Two-Tone: Zone A (Outter Shell) 3ly Zone B (Inside Cushions) 3ly

Gnarly Low Back	Yardage	COM	A	B	C	D	E	F	G	H	I
Solid	5	\$2,797	\$2,964	\$3,047	\$3,164	\$3,264	\$3,397	\$3,564	\$3,730	\$4,041	\$4,308
Two-Tone	6	\$2,851	\$3,051	\$3,151	\$3,291	\$3,411	\$3,571	\$3,771	\$3,971	\$4,344	\$4,664

*If the textiles used in multi-zoning are different grades, use price of the higher grade level.

GNARLY OTTOMAN

Designed by SIXINCH® USA

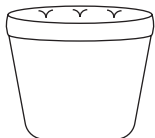

Model: Gnarly Ottoman
Weight: Approx 26 lbs.
Shell: Wood
Base: Wood Base w/Glides
Glides: Plastic (Black)
Seat: Upholstered Foam
Zoning: Solid, Shell+Cushion

Dimensions:
 W: 20
 D: 20
 H: 22
 SH: 22

Fabric Required:

- **Solid:** 2ly
- **Two-Tone:** Zone A (Outer Shell) 2ly Zone B (Cushion) 1ly

Gnarly Low Back	Yardage	COM	A	B	C	D	E	F	G	H	I
Solid / Two-Tone	3	\$1,213	\$1,313	\$1,363	\$1,433	\$1,503	\$1,573	\$1,673	\$1,773	\$1,960	\$2,120

*If the textiles used in multi-zoning are different grades, use price of the higher grade level.

GNARLY ZONING

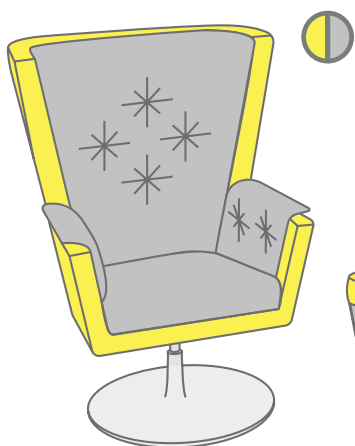

SOLID

Two-Tone

FABRIC 1
 ZONE A - SHELL

FABRIC 2
 ZONE B - INSIDE/ARM PADS

SOLID

Two-Tone

FABRIC 1
 ZONE A - SIDE

FABRIC 2
 ZONE B - SEAT

GLO

Designed by Stiwood

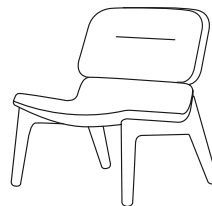

Model: Glo Lounge
Weight: Approx 40 lbs.
Shell: Wood
Base: 8 base options
Seat: Upholstered Foam
Zoning: Solid, Back+Seat, Seat

Dimensions (4 Leg wood):

W: 23.5
 D: 29
 H: 33
 SH: 15.5

*Reference cut sheet for base and finish details

Fabric Required:

- **Solid:** 2.5ly
- **Two-Tone:** (Back+Seat) 2ly (Shell) .5ly
- **Two-Tone:** (Seat) .5ly (Back+Shell) 2ly

Glo - In Stock Bases	Yardage	COM	A	B	C	D	E	F	G	H	I
4 Leg Wood*	2.5	\$1,870	\$1,953	\$1,995	\$2,053	\$2,112	\$2,170	\$2,253	\$2,337	\$2,492	\$2,625
Rocker Wood*	2.5	\$1,805	\$1,888	\$1,930	\$1,988	\$2,047	\$2,105	\$2,188	\$2,272	\$2,427	\$2,560
Pyramidal Wood*	2.5	\$1,821	\$1,904	\$1,946	\$2,004	\$2,063	\$2,121	\$2,204	\$2,288	\$2,443	\$2,576
4 Leg Tube Metal*	2.5	\$1,547	\$1,630	\$1,672	\$1,730	\$1,789	\$1,847	\$1,930	\$2,014	\$2,169	\$2,302
Glo - Imported Bases		13-16 week lead time, plus possible mins - Please call to confirm.									
4 Star Metal	2.5	\$1,800	\$1,883	\$1,925	\$1,983	\$2,042	\$2,100	\$2,183	\$2,267	\$2,422	\$2,555
Sled Metal	2.5	\$1,676	\$1,759	\$1,801	\$1,859	\$1,918	\$1,976	\$2,059	\$2,143	\$2,298	\$2,431
Pedestal Metal	2.5	\$2,295	\$2,378	\$2,420	\$2,478	\$2,537	\$2,595	\$2,678	\$2,762	\$2,917	\$3,050
Pyramidal Metal	2.5	\$1,784	\$1,867	\$1,909	\$1,967	\$2,026	\$2,084	\$2,167	\$2,251	\$2,406	\$2,539

*Inventory / Shorter lead time. See cut sheet for finishes.

**If the textiles used in multi-zoning are different grades, use price of the higher grade level.

GLO ZONING



LEVEL 1

Designed by Josh Sweazy for SIXINCH USA



Model: Levels 1
Weight: Approx
Leg Type: Leveling Glides
Glide Finish: Black
Material: Upholstered Foam
Zoning: Solid, (2) Zoning Areas
Options: Hard Surface, Storage

Fabric Required:
 • Solid: 1.75ly
 • Two-Tone: Zone A 1y Zone B 1y

Dimensions:
 W: 36
 D: 18
 H: 12
 SH: 18

FlexPlus List Price \$2,933

Upgrades
[Add to List Price](#)

+260 Power - (2) 110v
 +425 Power - (1) 110v (1) USB
 +300 Hard Surface
 +400 Storage

Levels 1	Yardage	COM	A	B	C	D	E	F	G	H	I
Upholstered	1.75	\$700	\$758	\$787	\$828	\$863	\$910	\$968	\$1,027	\$1,135	\$1,229
Hard Surface upholstered	1.25	\$1,000	\$1,042	\$1,062	\$1,092	\$1,117	\$1,150	\$1,192	\$1,233	\$1,311	\$1,378
Storage upholstered	2.25	\$1,100	\$1,175	\$1,212	\$1,265	\$1,310	\$1,370	\$1,445	\$1,520	\$1,660	\$1,780

*If the textiles used in multi-zoning are different grades, use price of the higher grade level.

*Power requires hard surface.

*FlexPlus has no option for power or hard surface.

LEVEL 2 - SLIDE

Designed by Josh Sweazy for SIXINCH USA

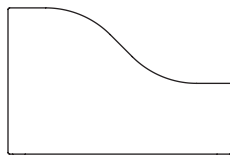

Model: Levels 2 Slide
Weight: Approx
Leg Type: Leveling Glides
Glide Finish: Black
Material: Upholstered Foam
Zoning: Solid, (2) Zoning Areas
Options: Hard Surface, Storage

Fabric Required:
 • Solid: 2.25ly
 • Two-Tone: Zone A 1y Zone B 1y

Dimensions:
 W: 36
 D: 18
 H: 22-12
 SH: 22-12

FlexPlus List Price \$3,703

Levels 2 - Slide	Yardage	COM	A	B	C	D	E	F	G	H	I
Upholstered	2.25	\$950	\$1,025	\$1,062	\$1,115	\$1,160	\$1,220	\$1,295	\$1,370	\$1,510	\$1,630

*If the textiles used in multi-zoning are different grades, use price of the higher grade level.

*Power requires hard surface.

*FlexPlus has no option for power or hard surface.

LEVEL 2

Designed by Josh Sweazy for SIXINCH USA

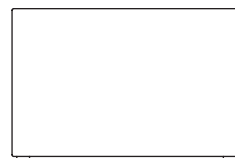

Model: Levels 2
Weight: Approx
Leg Type: Leveling Glides
Glide Finish: Black
Material: Upholstered Foam
Zoning: Solid, (2) Zoning Areas
Options: Hard Surface, Storage

Fabric Required:
 • Solid: 2.25ly
 • Two-Tone: Zone A 1y Zone B 1y

Dimensions:
 W: 36
 D: 18
 H: 22
 SH: 18

FlexPlus List Price \$3,739

Upgrades
[Add to List Price](#)

+260 Power - (2) 110v
 +425 Power - (1) 110v (1) USB
 +300 Hard Surface
 +400 Storage

Levels 1	Yardage	COM	A	B	C	D	E	F	G	H	I
Upholstered	2.25	\$900	\$975	\$1,012	\$1,065	\$1,110	\$1,170	\$1,245	\$1,320	\$1,460	\$1,580
Hard Surface upholstered	2.25	\$1,200	\$1,275	\$1,312	\$1,365	\$1,410	\$1,470	\$1,545	\$1,620	\$1,760	\$1,880
Storage upholstered	2.25	\$1,300	\$1,375	\$1,412	\$1,465	\$1,510	\$1,570	\$1,645	\$1,720	\$1,860	\$1,980

*If the textiles used in multi-zoning are different grades, use price of the higher grade level.

*Power requires hard surface.

*FlexPlus has no option for power or hard surface.

LEVEL 3

Designed by Josh Sweazy for SIXINCH USA

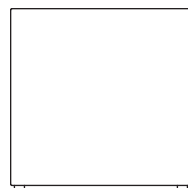

Model: Levels 3
Weight: Approx
Leg Type: Leveling Glides
Glide Finish: Black
Material: Upholstered Foam
Zoning: Solid, (2) Zoning Areas
Options: Hard Surface, Storage

Fabric Required:
 • Solid: 3.25ly
 • Two-Tone: Zone A 1y Zone B 1y

Dimensions:
 W: 36
 D: 18
 H: 32
 SH: 32

FlexPlus List Price \$4,613

Upgrades
[Add to List Price](#)

+260 Power - (2) 110v
 +425 Power - (1) 110v (1) USB
 +300 Hard Surface
 +400 Storage

Levels 3	Yardage	COM	A	B	C	D	E	F	G	H	I
Upholstered	3.25	\$1,100	\$1,208	\$1,262	\$1,338	\$1,403	\$1,490	\$1,598	\$1,707	\$1,909	\$2,082
Hard Surface upholstered	3.25	\$1,400	\$1,508	\$1,562	\$1,638	\$1,703	\$1,790	\$1,898	\$2,007	\$2,209	\$2,382
Storage upholstered	3.25	\$1,500	\$1,608	\$1,662	\$1,738	\$1,803	\$1,890	\$1,998	\$2,107	\$2,309	\$2,482

*If the textiles used in multi-zoning are different grades, use price of the higher grade level.

*Power requires hard surface.

*FlexPlus has no option for power or hard surface.

LEVEL 3 - SLIDE

Designed by Josh Sweazy for SIXINCH USA

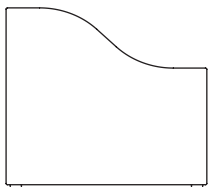

Model: Levels 3 Slide
Weight: Approx
Leg Type: Leveling Glides
Glide Finish: Black
Material: Upholstered Foam
Zoning: Solid, (2) Zoning Areas
Options: Hard Surface, Storage

Dimensions: **FlexPlus List Price \$4,484**
 W: 36
 D: 18
 H: 32-22
 SH: 32-22

Fabric Required:
 • Solid: 2.75ly
 • Two-Tone: Zone A ly Zone B ly

Level 3 - Upholstered	Yardage	COM	A	B	C	D	E	F	G	H	I
Upholstered	2.75	\$1,150	\$1,242	\$1,287	\$1,352	\$1,407	\$1,480	\$1,572	\$1,663	\$1,834	\$1,981

*If the textiles used in multi-zoning are different grades, use price of the higher grade level.

*Power requires hard surface.

*FlexPlus has no option for power or hard surface.

LEVEL ZONING

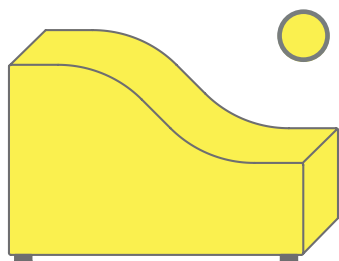

SOLID

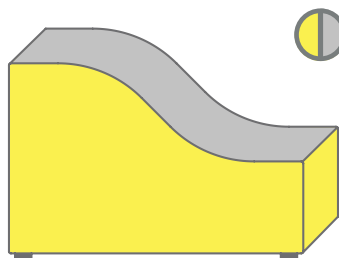

TWO TONE
FABRIC 1
 ZONE A - SIDES
FABRIC 2
 ZONE B - SEAT

LEVEL TOPPER

Designed by SIXINCH® USA



Model: Level Topper
Weight: Approx 5 lbs.
Material: Metal
Finish: Powder Coated

Dimensions: **List Price \$280**
 W: 15
 D: 18.5
 H: 3.5

LEVELS LVL - GANGING

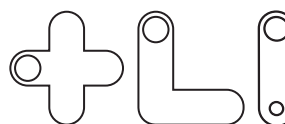

Model: Elements Ganging
Weight: Approx 1 lbs.
Type: X,L, I Option (see below)
Material: HDPE
Color: Black

LIST Price \$115
 *Pack of (4) - Same style
LIST Price \$40
 * (1) Unit

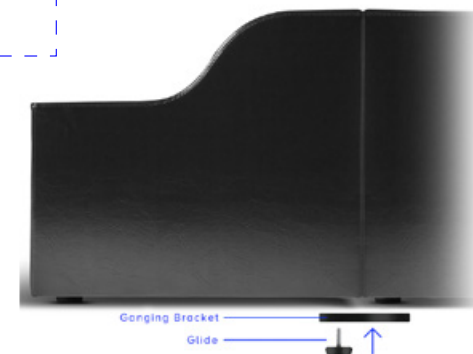
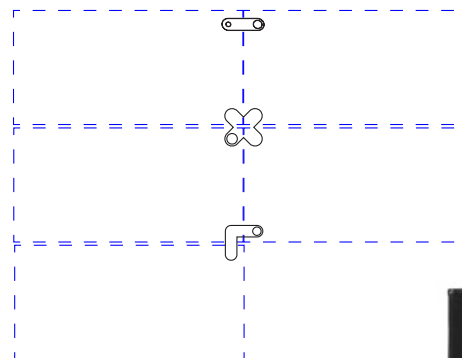

TAPA 1

Designed by Mac Stopa

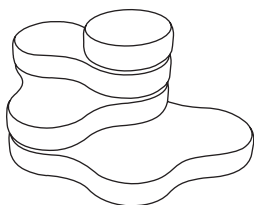

Model: Tapa 1
Weight: Approx 125 lbs.
Leg Type: Leveling Glides
Glide Finish: Black
Material: Upholstered Foam
Zoning: Solid, (4) Zoning Areas
Pivot Point: Center

Dimensions:
W: 43
D: 30
H: 25

Fabric Required:
• **Solid:** 4.5ly
• **Four-Tone:** Zone 1 2ly Zone 2 2ly Zone 3 1.5ly Zone 4 1ly

Tapa 1	Yardage	COM	A	B	C	D	E	F	G	H	I
	4.5	\$4,070	\$4,220	\$4,295	\$4,400	\$4,505	\$4,610	\$4,760	\$4,910	\$5,190	\$5,430

*If the textiles used in multi-zoning are different grades, use price of the higher grade level.
*Each section is 6" in height.

TAPA 1 POUF

Designed by Mac Stopa

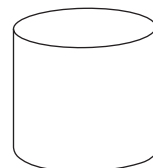

Model: Tapa 1 Pouf
Weight: Approx 20 lbs.
Base: Zipper or Wood Base w/Glides
Leg Type: Glides
Glide Finish: Black
Material: Upholstered Foam

Dimensions:
W: 16
D: 16
H: 6-13.5

FlexPlus List Price
7.5" Height \$785
13.5" Height \$1,015

***Wood Base+Glides only*

TP1-06: 16" Diameter, 6" Height / **Wood Base** **TP1-06:** 16" Diameter, 7.5" Height / **Wood Base+Glides**
TP1-12: 16" Diameter, 12" Height / **Wood Base** **TP1-12:** 16" Diameter, 13.5" Height / **Wood Base+Glides**

Tapa 1 Pouf	Yardage	COM	A	B	C	D	E	F	G	H	I
TP1-06 Wood	1	\$409	\$442	\$459	\$482	\$506	\$529	\$562	\$596	\$658	\$711
TP1-12 Wood	1.5	\$616	\$666	\$691	\$726	\$761	\$796	\$846	\$896	\$989	\$1,069
TP1-6 Wood+Glides	1	\$413	\$446	\$463	\$486	\$510	\$533	\$566	\$600	\$662	\$715
TP1-12 Wood+Glides	1.5	\$620	\$670	\$695	\$730	\$765	\$800	\$850	\$900	\$993	\$1,073

TAPA 2

Designed by Mac Stopa

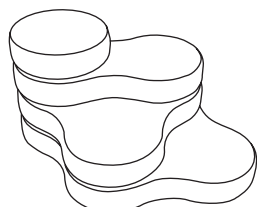

Model: Tapa 2
Weight: Approx 125 lbs.
Leg Type: Leveling Glides
Glide Finish: Black
Material: Upholstered Foam
Zoning: Solid, (4) Zoning Areas
Pivot Point: End

Dimensions:
W: 43
D: 30
H: 25

Fabric Required:
• **Solid:** 4.5ly
• **Four-Tone:** Zone 1 2ly Zone 2 2ly Zone 3 1.5ly Zone 4 1ly

Tapa 2	Yardage	COM	A	B	C	D	E	F	G	H	I
	4.5	\$4,070	\$4,220	\$4,295	\$4,400	\$4,505	\$4,610	\$4,760	\$4,910	\$5,190	\$5,430

*If the textiles used in multi-zoning are different grades, use price of the higher grade level.
*Each section is 6" in height.

TAPA 2 POUF (PEANUT)

Designed by Mac Stopa



Model: Tapa 2 Pouf
Weight: Approx 25 lbs.
Base: Zipper or Wood Base w/Glides
Leg Type: Glides
Glide Finish: Black
Material: Upholstered Foam

Dimensions:
W: 32
D: 12
H: 6-13.5

FlexPlus List Price
7.5" Height \$1,100
13.5" Height \$1,370

***Wood Base+Glides only*

TP2-06: 16" Diameter, 6" Height / **Wood Base** **TP2-06:** 16" Diameter, 7.5" Height / **Wood Base+Glides**
TP2-12: 16" Diameter, 12" Height / **Wood Base** **TP2-12:** 16" Diameter, 13.5" Height / **Wood Base+Glides**

Tapa 1 Pouf	Yardage	COM	A	B	C	D	E	F	G	H	I
TP1-06 Wood	2	\$709	\$776	\$809	\$856	\$902	\$949	\$1,016	\$1,082	\$1,207	\$1,313
TP1-12 Wood	2	\$928	\$995	\$1,028	\$1,075	\$1,121	\$1,168	\$1,235	\$1,301	\$1,426	\$1,532
TP1-6 Wood+Glides	2	\$716	\$783	\$816	\$863	\$909	\$956	\$1,023	\$1,089	\$1,214	\$1,320
TP1-12 Wood+Glides	2	\$935	\$1,002	\$1,035	\$1,082	\$1,128	\$1,175	\$1,242	\$1,308	\$1,433	\$1,539

TAPA 3 POUF (FIDGET)

Designed by Mac Stopa

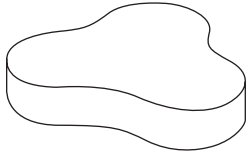

Model: Tapa 3 Pouf
Weight: Approx 45 lbs.
Base: Zipper or Wood Base w/Glides
Leg Type: Glides
Glide Finish: Black
Material: Upholstered Foam

Dimensions:
 W: 32
 D: 24
 H: 6-7.5

FlexPlus List Price
 7.5" Height **\$1,455**
**Wood Base+Glides only

TP3-06: 16" Diameter, 6" Height / Wood Base TP3-06: 16" Diameter, 7.5" Height / Wood Base+Glides

Tapa 3 Pouf (Fidget)	Yardage	COM	A	B	C	D	E	F	G	H	I
TP1-06 Wood	2	\$890	\$957	\$990	\$1,037	\$1,083	\$1,130	\$1,197	\$1,263	\$1,388	\$1,494
TP1-6 Wood+Glides	2	\$901	\$968	\$1,001	\$1,048	\$1,094	\$1,141	\$1,208	\$1,274	\$1,399	\$1,505

TAPA ZONING

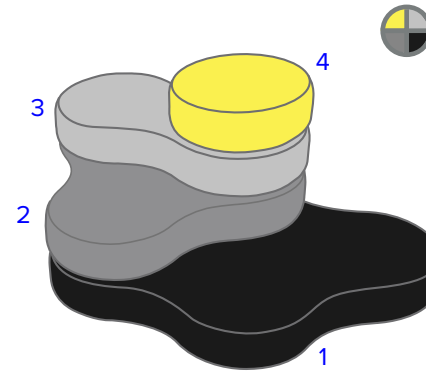

SOLID

FOUR TONE

FABRIC 1
 TIER 1 (Base)
FABRIC 2
 TIER 2
FABRIC 3
 TIER 3
FABRIC 4
 TIER 4 (Top)

TAPA ROTATION / NESTING

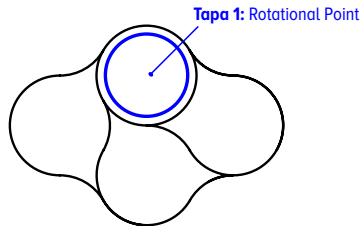

Tapa 1: Rotational Point

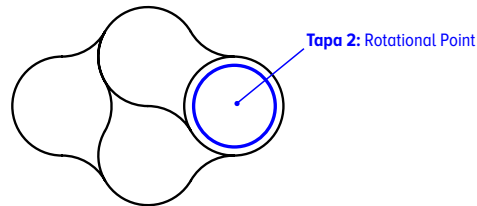

Tapa 2: Rotational Point

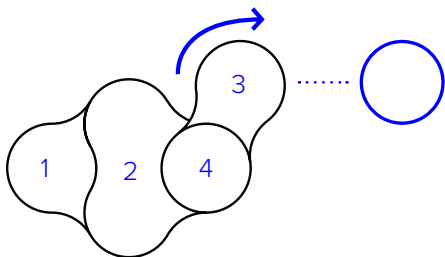

6" Tapa Poufs
 Slide underneath Zone 2 for support when rotated

12" Tapa Poufs
 Slide underneath Zone 3 for support when rotated

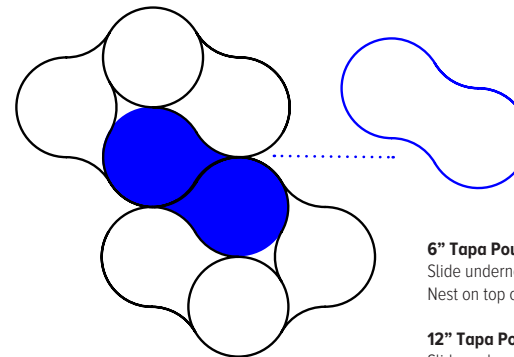

6" Tapa Pouf 2 (Peanut)
 Slide underneath Zone 2 for support -or-
 Nest on top of two units for unique looks

12" Tapa Pouf 2 (Peanut)
 Slide underneath Zone 3 for support -or-
 Nest on top of two units for unique looks

TAPA SQUARE

Designed by Mac Stopa

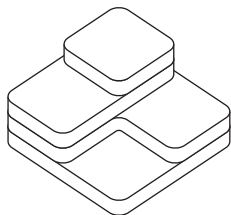

Model: Tapa Square
Weight: Approx 165 lbs.
Leg Type: Leveling Glides
Glide Finish: Black
Material: Upholstered Foam
Zoning: Solid, (4) Zoning Areas
Pivot Point: Corner

Dimensions:
W: 36
D: 36
H: 25

Fabric Required:
 • **Solid:** 4.5ly
 • **Four-Tone:** Zone 1 2ly Zone 2 2ly Zone 3 1.5ly Zone 4 1ly

Tapa Square	Yardage	COM	A	B	C	D	E	F	G	H	I
	4.5	\$4,244	\$4,394	\$4,469	\$4,574	\$4,679	\$4,784	\$4,934	\$5,084	\$5,364	\$5,604

*If the textiles used in multi-zoning are different grades, use price of the higher grade level.
 *Each section is 6" in height.

TAPA SQ ZONING

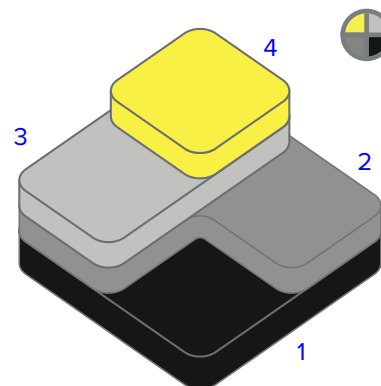

SOLID

FOUR TONE

FABRIC 1
 TIER 1 (Base)
FABRIC 2
 TIER 2
FABRIC 3
 TIER 3
FABRIC 4
 TIER 4 (Top)

TAPA SQUARE POUF

Designed by Mac Stopa

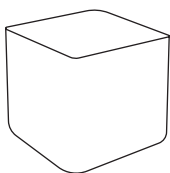

Model: Tapa Square
Weight: Approx 17 lbs.
Leg Type: Leveling Glides
Glide Finish: Black
Material: Upholstered Foam
Zoning: Solid, (4) Zoning Areas
Pivot Point: Corner

Dimensions:
W: 16
D: 16
H: *see below

FlexPlus List Price \$Call

TSP1-06: 16" Square, 7.5" Height / **Wood Base+Glides**
TSP1-12: 16" Square, 13.5" Height / **Wood Base+Glides**
TSP1-18: 16" Square, 19.5" Height / **Wood Base+Glides**

Tapa Square Pouf	Yardage	COM	A	B	C	D	E	F	G	H	I
TSP1-06 Wood	1	\$570	\$603	\$620	\$643	\$667	\$690	\$723	\$757	\$819	\$872
TSP1-12 Wood	1	\$712	\$745	\$762	\$785	\$809	\$832	\$865	\$899	\$961	\$1,014
TSP1-18 Wood	1.5	\$863	\$913	\$938	\$973	\$1,008	\$1,043	\$1,093	\$1,143	\$1,236	\$1,316

TAPA SQ NESTING

6" Tapa Poufs

Slide underneath Zone 2 for support when rotated

12" Tapa Poufs

Slide underneath Zone 3 for support when rotated

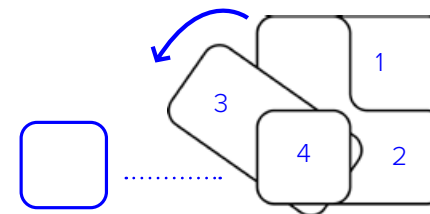

ISLAND 1

Designed by Rainer Mutsch

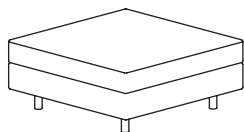

Model: Island 1
Weight: Approx
Base: Wood
Feet: Powder Coated Metal
Feet Color: Silver
Material: Upholstered Foam
Options: Solid, Two-Tone

Dimensions:
 W: 34
 D: 34
 H: 14.5
 SH: 14.5

Fabric Required:
 • Solid: 3ly
 • Two-Tone: Zone A 2ly Zone B 2ly

Island 1	Yardage	COM	A	B	C	D	E	F	G	H	I
Solid	3	\$1,644	\$1,744	\$1,794	\$1,864	\$1,934	\$2,004	\$2,104	\$2,204	\$2,391	\$2,551
Two-Tone	4	\$1,556	\$1,689	\$1,756	\$1,849	\$1,929	\$2,036	\$2,169	\$2,303	\$2,551	\$2,765

*If the textiles used in multi-zoning are different grades, use price of the higher grade level.

ISLAND 3

Designed by Rainer Mutsch

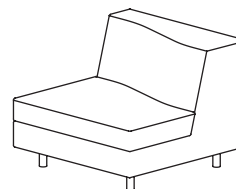

Model: Island 3
Weight: Approx
Base: Wood
Feet: Powder Coated Metal
Feet Color: Silver
Material: Upholstered Foam
Options: Solid, Two-Tone

Dimensions:
 W: 34
 D: 34
 H: 26.5
 SH: 14.5
 SD: 20-24

Fabric Required:
 • Solid: 4ly
 • Two-Tone: Zone A 3ly Zone B 2ly

Island 3	Yardage	COM	A	B	C	D	E	F	G	H	I
Solid	4	\$2,217	\$2,350	\$2,417	\$2,510	\$2,604	\$2,697	\$2,830	\$2,964	\$3,212	\$3,426
Two-Tone	5	\$2,293	\$2,460	\$2,543	\$2,660	\$2,776	\$2,893	\$3,060	\$3,226	\$3,537	\$3,804

*If the textiles used in multi-zoning are different grades, use price of the higher grade level.

ISLAND 2

Designed by Rainer Mutsch

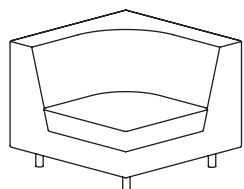

Model: Island 2
Weight: Approx
Base: Wood
Feet: Powder Coated Metal
Feet Color: Silver
Material: Upholstered Foam
Options: Solid, Two-Tone

Dimensions:
 W: 34
 D: 34
 H: 26.5
 SH: 14.5
 SD: 24

Fabric Required:
 • Solid: 4ly
 • Two-Tone: Zone A 3ly Zone B 2ly

Island 2	Yardage	COM	A	B	C	D	E	F	G	H	I
Solid	4	\$2,525	\$2,658	\$2,725	\$2,818	\$2,912	\$3,005	\$3,138	\$3,272	\$3,520	\$3,734
Two-Tone	5	\$2,600	\$2,767	\$2,850	\$2,967	\$3,083	\$3,200	\$3,367	\$3,533	\$3,844	\$4,111

*If the textiles used in multi-zoning are different grades, use price of the higher grade level.

ISLAND 4

Designed by Rainer Mutsch

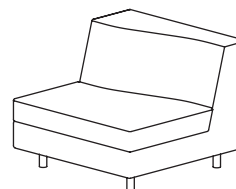

Model: Island 4
Weight: Approx
Base: Wood
Feet: Powder Coated Metal
Feet Color: Silver
Material: Upholstered Foam
Options: Solid, Two-Tone

Dimensions:
 W: 34
 D: 34
 H: 26.5
 SH: 14.5
 SD: 20-24

Fabric Required:
 • Solid: 4ly
 • Two-Tone: Zone A 3ly Zone B 2ly

Island 4	Yardage	COM	A	B	C	D	E	F	G	H	I
Solid	4	\$2,217	\$2,350	\$2,417	\$2,510	\$2,604	\$2,697	\$2,830	\$2,964	\$3,212	\$3,426
Two-Tone	5	\$2,293	\$2,460	\$2,543	\$2,660	\$2,776	\$2,893	\$3,060	\$3,226	\$3,537	\$3,804

*If the textiles used in multi-zoning are different grades, use price of the higher grade level.

ISLAND 5

Designed by Rainer Mutsch

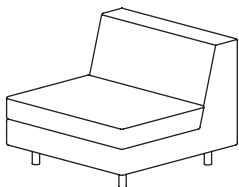

Model: Island 5
Weight: Approx
Base: Wood
Feet: Powder Coated Metal
Feet Color: Silver
Material: Upholstered Foam
Options: Solid, Two-Tone

Dimensions:
W: 34
D: 34
H: 26.5
SH: 14.5
SD: 24

Fabric Required:

- **Solid:** 4ly
- **Two-Tone:** Zone A 3ly Zone B 2ly

Island 5	Yardage	COM	A	B	C	D	E	F	G	H	I
Solid	4	\$1,985	\$2,118	\$2,185	\$2,278	\$2,372	\$2,465	\$2,598	\$2,732	\$2,980	\$3,194
Two-Tone	5	\$2,061	\$2,228	\$2,311	\$2,428	\$2,544	\$2,661	\$2,828	\$2,994	\$3,305	\$3,572

*If the textiles used in multi-zoning are different grades, use price of the higher grade level.

ISLAND 7

Designed by Rainer Mutsch

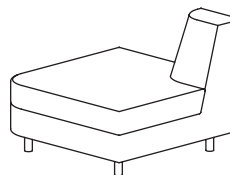

Model: Island 7
Weight: Approx
Base: Wood
Feet: Powder Coated Metal
Feet Color: Silver
Material: Upholstered Foam
Options: Solid, Two-Tone

Dimensions:
W: 34
D: 34
H: 26.5
SH: 14.5
SD: 24

Fabric Required:

- **Solid:** 4ly
- **Two-Tone:** Zone A 2ly Zone B 2ly

Island 7	Yardage	COM	A	B	C	D	E	F	G	H	I
Solid	4	\$2,243	\$2,376	\$2,443	\$2,536	\$2,630	\$2,723	\$2,856	\$2,990	\$3,238	\$3,452
Two-Tone	4	\$2,289	\$2,422	\$2,489	\$2,582	\$2,676	\$2,769	\$2,902	\$3,036	\$3,284	\$3,498

*If the textiles used in multi-zoning are different grades, use price of the higher grade level.

ISLAND 6

Designed by Rainer Mutsch

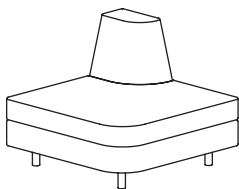

Model: Island 6
Weight: Approx
Base: Wood
Feet: Powder Coated Metal
Feet Color: Silver
Material: Upholstered Foam
Options: Solid, Two-Tone

Dimensions:
W: 34
D: 34
H: 26.5
SH: 14.5
SD: 24

Fabric Required:

- **Solid:** 4ly
- **Two-Tone:** Zone A 2ly Zone B 2ly

Island 6	Yardage	COM	A	B	C	D	E	F	G	H	I
Solid	4	\$2,243	\$2,376	\$2,443	\$2,536	\$2,630	\$2,723	\$2,856	\$2,990	\$3,238	\$3,452
Two-Tone	4	\$2,289	\$2,422	\$2,489	\$2,582	\$2,676	\$2,769	\$2,902	\$3,036	\$3,284	\$3,498

*If the textiles used in multi-zoning are different grades, use price of the higher grade level.

ISLAND 8

Designed by Rainer Mutsch

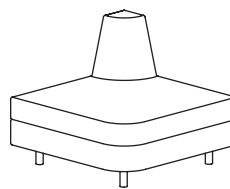

Model: Island 8
Weight: Approx
Base: Wood
Feet: Powder Coated Metal
Feet Color: Silver
Material: Upholstered Foam
Options: Solid, Two-Tone

Dimensions:
W: 34
D: 34
H: 26.5
SH: 14.5
SD: 24

Fabric Required:

- **Solid:** 4ly
- **Two-Tone:** Zone A 2ly Zone B 2ly

Island 8	Yardage	COM	A	B	C	D	E	F	G	H	I
Solid	4	\$2,243	\$2,376	\$2,443	\$2,536	\$2,630	\$2,723	\$2,856	\$2,990	\$3,238	\$3,452
Two-Tone	4	\$2,289	\$2,422	\$2,489	\$2,582	\$2,676	\$2,769	\$2,902	\$3,036	\$3,284	\$3,498

*If the textiles used in multi-zoning are different grades, use price of the higher grade level.

ISLAND ZONING

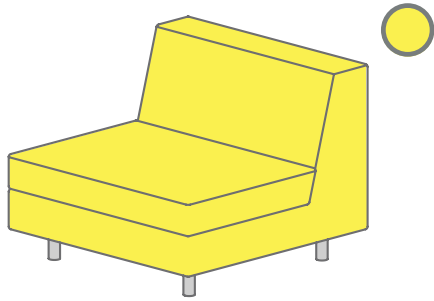

SOLID

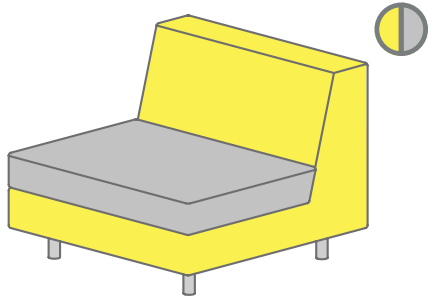

Two-Tone
FABRIC 1
 ZONE A - BACK AND SIDES
FABRIC 2
 ZONE B - SEAT

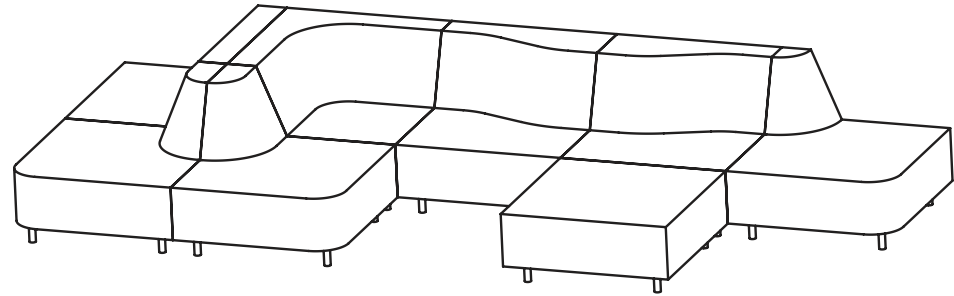

ELEMENTS - STANDARD SEAT

Designed by POPULOUS

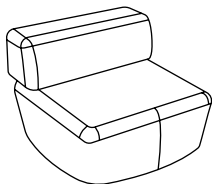

Model: Elements Standard Seat
Weight: Approx 57 lbs.
Leg Type: Leveling Glides
Glide Finish: Black
Material: Upholstered Foam
Zoning: Solid, (2) Zoning Areas
Options: Blanket Feature

Dimensions:
W: 37
D: 37
H: 28
SH: 15
SD: 24

Upgrades
[Add to List Price](#)
+Chart Blanket Feature
+\$112 HDPE Ganging Bracket
**Sold in packs of (4)*

Fabric Required:
• **Solid:** 4.5ly
• **Two-Tone: Zone A (Seat) 3.5ly Zone B (Back) 1.25ly**
• **Blanket:** 3ly

Elements Standard	Yardage	COM	A	B	C	D	E	F	G	H	I
	4.5	\$2,600	\$2,758	\$2,837	\$2,948	\$3,043	\$3,170	\$3,328	\$3,487	\$3,782	\$4,035

*If the textiles used in multi-zoning are different grades, use price of the higher grade level.

Elements Blanket	Yardage	COM	A	B	C	D	E	F	G	H	I
	3	\$300	\$400	\$450	\$520	\$580	\$660	\$760	\$860	\$1,047	\$1,207

*Blanket feature offers 11 standard quilting options along with contrast stitching (Black, Blue, Grey, Red, White, Matching).

*Blanket feature can be added after initial purchase with hidden snaps under back rest.

ELEMENTS - CORNER

Designed by POPULOUS

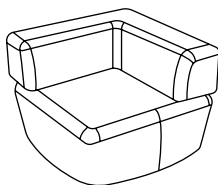

Model: Elements Corner
Weight: Approx 69 lbs.
Leg Type: Leveling Glides
Glide Finish: Black
Material: Upholstered Foam
Zoning: Solid, (2) Zoning Areas

Dimensions:
W: 37
D: 37
H: 28
SH: 15
SD: 24

Upgrades
[Add to List Price](#)
+ \$112 HDPE Ganging Bracket
**Sold in packs of (4)*

Fabric Required:
• **Solid:** 5.5ly
• **Two-Tone: Zone A (Seat) 3.5ly Zone B (Back) 2.5ly**

Elements Corner	Yardage	COM	A	B	C	D	E	F	G	H	I
	5.5	\$3,071	\$3,271	\$3,371	\$3,511	\$3,651	\$3,791	\$3,991	\$4,191	\$4,564	\$4,884

*If the textiles used in multi-zoning are different grades, use price of the higher grade level.

ELEMENTS - ARM

Designed by POPULOUS

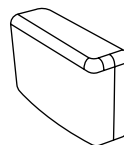

Model: Elements Arm
Weight: Approx 35 lbs.
Leg Type: Leveling Glides
Glide Finish: Black
Material: Upholstered Foam
Zoning: Solid
Options: Power

Dimensions:
W: 13
D: 37
H: 25

Upgrades
[Add to List Price](#)
+Chart Byrne Electric Qi and USB charger
+\$112 HDPE Ganging Bracket
**Sold in packs of (4)*

Fabric Required: Solid: 2ly

Elements Arm	Yardage	COM	A	B	C	D	E	F	G	H	I
Upholstered	2	\$1,045	\$1,112	\$1,145	\$1,192	\$1,238	\$1,285	\$1,352	\$1,418	\$1,543	\$1,649
Upholstered w/Power	2	\$2,072	\$2,139	\$2,172	\$2,219	\$2,265	\$2,312	\$2,379	\$2,445	\$2,570	\$2,676

ELEMENTS - 45 CORNER

Designed by POPULOUS

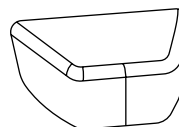

Model: Elements 45 Corner
Weight: Approx 30 lbs.
Leg Type: Leveling Glides
Glide Finish: Black
Material: Upholstered Foam
Zoning: Solid

Dimensions:
W: 44
D: 31
H: 15
SH: 15

Upgrades
[Add to List Price](#)
+ \$112 HDPE Ganging Bracket
**Sold in packs of (4)*

Fabric Required: Solid: 3ly

Elements 45 Corner	Yardage	COM	A	B	C	D	E	F	G	H	I
	3	\$1,806	\$1,906	\$1,956	\$2,026	\$2,096	\$2,166	\$2,266	\$2,366	\$2,553	\$2,713

ELEMENTS - 90 CORNER

Designed by POPULOUS

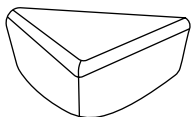

Model: Elements 90 Corner
Weight: Approx 30 lbs.
Leg Type: Leveling Glides
Glide Finish: Black
Material: Upholstered Foam
Zoning: Solid

Dimensions:
 W: 47
 D: 27.5
 H: 15
 SH: 15

Upgrades
[Add to List Price](#)
+\$112 HDPE Ganging Bracket
**Sold in packs of 4)*

Fabric Required: Solid: 2.75ly

Elements 90 Corner	Yardage	COM	A	B	C	D	E	F	G	H	I
	2.75	\$2,471	\$2,563	\$2,608	\$2,673	\$2,737	\$2,801	\$2,893	\$2,984	\$3,155	\$3,302

ELEMENTS - CHAISE CORNER LEFT

Designed by POPULOUS

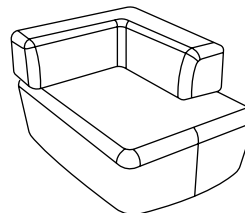

Model: Elements Chaise Corner Left
Weight: Approx 81 lbs.
Leg Type: Leveling Glides
Glide Finish: Black
Material: Upholstered Foam
Zoning: Solid, (2) Zoning Areas

Dimensions:
 W: 37
 D: 51
 H: 28
 SH: 15
 SD: 37

Upgrades
[Add to List Price](#)
+\$112 HDPE Ganging Bracket
**Sold in packs of 4)*

Fabric Required:
 • Solid: 6.25ly
 • Two-Tone: Zone A (Seat) 3.5ly Zone B (Back) 4ly

Elements Chaise Corner	Yardage	COM	A	B	C	D	E	F	G	H	I
	6.25	\$3,430	\$3,638	\$3,742	\$3,888	\$4,034	\$4,180	\$4,388	\$4,596	\$4,985	\$5,319

*If the textiles used in multi-zoning are different grades, use price of the higher grade level.

ELEMENTS - CHAISE W/BACK

Designed by POPULOUS

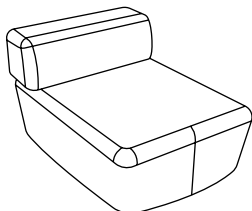

Model: Elements Chaise w/Back
Weight: Approx 60 lbs.
Leg Type: Leveling Glides
Glide Finish: Black
Material: Upholstered Foam
Zoning: Solid, (2) Zoning Areas
Options: Blanket Feature

Dimensions:
 W: 37
 D: 51
 H: 28
 SH: 15
 SD: 37

Upgrades
[Add to List Price](#)
+Chart Blanket Feature
+\$112 HDPE Ganging Bracket
**Sold in packs of 4)*

Fabric Required:
 • Solid: 5ly
 • Two-Tone: Zone A (Seat) 3.75ly Zone B (Back) 1.25ly
 • Blanket: 3ly

Elements Chaise w/Back	Yardage	COM	A	B	C	D	E	F	G	H	I
	5	\$3,082	\$3,249	\$3,332	\$3,449	\$3,565	\$3,682	\$3,849	\$4,015	\$4,326	\$4,593

*If the textiles used in multi-zoning are different grades, use price of the higher grade level.

Elements Blanket	Yardage	COM	A	B	C	D	E	F	G	H	I
	3	\$300	\$400	\$450	\$520	\$580	\$660	\$760	\$860	\$1,047	\$1,207

*Blanket feature offers 11 standard quilting options along with contrast stitching (Black, Blue, Grey, Red, White, Matching).

*Blanket feature can be added after initial purchase with hidden snaps under back rest.

ELEMENTS - CHAISE CORNER RIGHT

Designed by POPULOUS

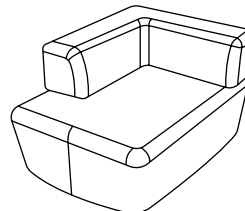

Model: Elements Chaise Corner Right
Weight: Approx 81 lbs.
Leg Type: Leveling Glides
Glide Finish: Black
Material: Upholstered Foam
Zoning: Solid, (2) Zoning Areas

Dimensions:
 W: 37
 D: 51
 H: 28
 SH: 15
 SD: 37

Upgrades
[Add to List Price](#)
+\$112 HDPE Ganging Bracket
**Sold in packs of 4)*

Fabric Required:
 • Solid: 6.25ly
 • Two-Tone: Zone A (Seat) 3.5ly Zone B (Back) 4ly

Elements Chaise Corner	Yardage	COM	A	B	C	D	E	F	G	H	I
	6.25	\$3,430	\$3,638	\$3,742	\$3,888	\$4,034	\$4,180	\$4,388	\$4,596	\$4,985	\$5,319

*If the textiles used in multi-zoning are different grades, use price of the higher grade level.

ELEMENTS - CHAISE OTTOMAN

Designed by POPULOUS

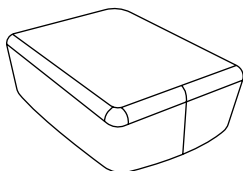

Model: Elements Chaise Ottoman
Weight: Approx 37 lbs.
Leg Type: Leveling Glides
Glide Finish: Black
Material: Upholstered Foam
Zoning: Solid

Dimensions:
 W: 37
 D: 51
 H: 15
 SH: 15

Upgrades
[Add to List Price](#)
+\$112 HDPE Ganging Bracket
**Sold in packs of 4)*

Fabric Required: Solid: 3.75ly

Elements Chaise Ottoman	Yardage	COM	A	B	C	D	E	F	G	H	I
	3.75	\$2,184	\$2,309	\$2,371	\$2,459	\$2,546	\$2,634	\$2,759	\$2,884	\$3,117	\$3,317

ELEMENTS - OTTOMAN

Designed by POPULOUS

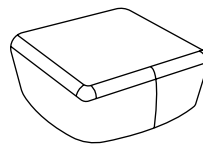

Model: Elements Ottoman
Weight: Approx 30 lbs.
Leg Type: Leveling Glides
Glide Finish: Black
Material: Upholstered Foam
Zoning: Solid

Dimensions:
 W: 37
 D: 37
 H: 15
 SH: 15

Upgrades
[Add to List Price](#)
+\$112 HDPE Ganging Bracket
**Sold in packs of 4)*

Fabric Required: Solid: 3.5ly

Elements Ottoman	Yardage	COM	A	B	C	D	E	F	G	H	I
	3.5	\$1,723	\$1,840	\$1,898	\$1,980	\$2,061	\$2,143	\$2,260	\$2,376	\$2,594	\$2,781

ELEMENTS - OTTOMAN TABLE

Designed by POPULOUS

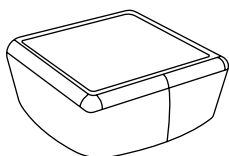

Model: Elements Ottoman
Weight: Approx 60 lbs.
Leg Type: Leveling Glides
Glide Finish: Black
Table Material: Acrylic Solid Surface
Table Finish: Polished
Material: Upholstered Foam
Zoning: Solid

Dimensions:
 W: 37
 D: 37
 H: 15

Upgrades
[Add to List Price](#)
+Chart Byrne Electric Qi and USB charger
+\$112 HDPE Ganging Bracket
**Sold in packs of 4)*

Fabric Required: Solid: 3.5ly

Elements Ottoman Table	Yardage	COM	A	B	C	D	E	F	G	H	I
Solid Surface	3.5	\$2,600	\$2,717	\$2,775	\$2,857	\$2,927	\$3,020	\$3,137	\$3,253	\$3,471	\$3,658
Solid Surface w/Power	3.5	\$3,434	\$3,551	\$3,609	\$3,691	\$3,772	\$3,854	\$3,971	\$4,087	\$4,305	\$4,492

ELEMENTS - ZONING

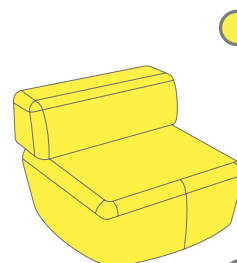

SOLID

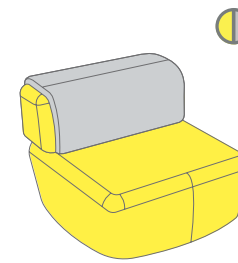

TWO TONE

FABRIC 1
 SEAT+BACK
FABRIC 2
 ACCENT BLANKET

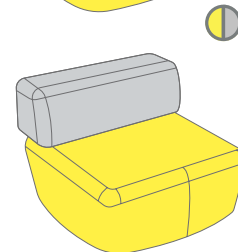

TWO TONE

FABRIC 1
 SEAT
FABRIC 2
 BACK

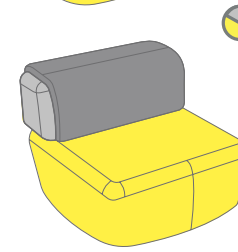

THREE TONE

FABRIC 1
 SEAT
FABRIC 2
 BACK
FABRIC 3
 ACCENT BLANKET

ELEMENTS - PULL-UP TABLE

Designed by POPULOUS



Model: Elements Ottoman
Weight: Approx 20 lbs.
Table Material: Acrylic Solid Surface
Table Finish: Polished
Leg/Base Finish: Powder Coated

Dimensions: **List Price \$1,100**
 W: 18
 D: 9
 H: 21.75

ELEMENTS - SOFA TABLE

Designed by POPULOUS

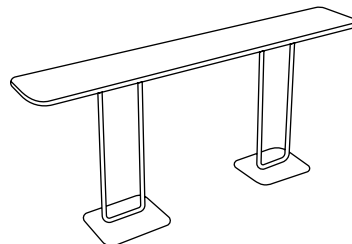

Model: Elements Sofa Table
Weight: Approx 105 lbs.
Table Material: Acrylic Solid Surface
Table Finish: Polished
Leg/Base Finish: Powder Coated

Dimensions: **List Price \$3,375**
 W: 72
 D: 12
 H: 30

ELEMENTS - SIDE TABLE

Designed by POPULOUS

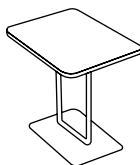

Model: Elements Side Table
Weight: Approx 53 lbs.
Table Material: Acrylic Solid Surface
Table Finish: Polished
Leg/Base Finish: Powder Coated

Dimensions: **List Price \$1,775**
 W: 24
 D: 18
 H: 19.75

ELEMENTS - GANGING

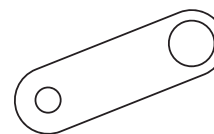

Model: Elements Ganging
Weight: Approx 1 lbs.
Material: HDPE
Color: Black

List Price \$115
 *Pack of (4)
List Price \$40
 * (1) Unit

ELEMENTS - COFFEE TABLE

Designed by POPULOUS

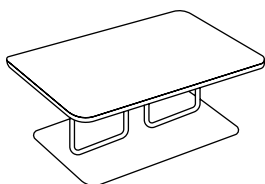

Model: Elements Coffe Table
Weight: Approx 155 lbs.
Table Material: Acrylic Solid Surface
Table Finish: Polished
Leg/Base Finish: Powder Coated

Dimensions: **List Price \$3,110**
 W: 41.5
 D: 29.5
 H: 15.5

ELEMENTS - SCREEN

Designed by POPULOUS

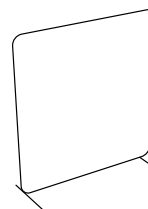

Model: Elements Divider
Weight: Approx 20 lbs.
Leg Type: Metal
Leg Finish: Powder Coat
Material: Upholstered Foam Cover
Leg/Base Finish: Powder Coated
Zoning: Solid
Quilting: Yes

Dimensions:
 W: 37
 H: 42.5

Upgrades
[Add to List Price](#)
+\$100 Contrast Stitching

Fabric Required: Solid: 5ly

Elements Divider	Yardage	COM	A	B	C	D	E	F	G	H	I
	2	\$1,800	\$1,867	\$1,900	\$1,947	\$1,993	\$2,040	\$2,107	\$2,173	\$2,298	\$2,404

*Divider offers 11 standrd quilting options along with contrast stitching (Black, Blue, Grey, Red, White, Matching).

WORK HEIGHT ELEVATE - SINGLE

Designed by POPULOUS

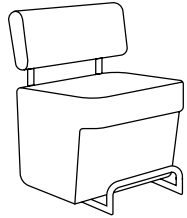

Model: Elevate Single
Weight: Approx 65 lbs
Material: Upholstered
Wood: Marine-grade Plywood
Leg Type: Leveling Glides
Glide Finish: Black
Material: Metal
Powder Coat: Standard 8 colors

Fabric Required:

Solid: 4ly
Two-Tone: Zone A (Seat/Sides) 3.5ly Zone B (Kick Plate) 1ly

Dimensions:

W: 27
D: 29
H: 39.5
SH: 24
SD: 20

Power Upgrades (Inside use only)
[Add to List Price](#)

+\$390 Salt®
+\$390 Pepper®

BYRNE

**Please specify LH sit, RH sit or both LH/RH sit for the power location(s)*

Elevate Work Single	Yardage	COM	A	B	C	D	E	F	G	H	I
Upholstered	4	\$2,581	\$2,714	\$2,781	\$2,874	\$2,968	\$3,061	\$3,194	\$3,328	\$3,576	\$3,790

*If the textiles used in multi-zoning are different grades, use price of the higher grade level.

WORK HEIGHT ELEVATE - DOUBLE

Designed by POPULOUS

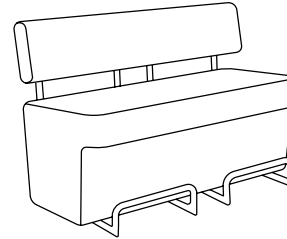

Model: Elevate Double
Weight: Approx 125
Material: Upholstered
Wood: Marine-grade Plywood
Leg Type: Leveling Glides
Glide Finish: Black
Material: Metal
Powder Coat: Standard 8 colors

Fabric Required:

Solid: 6.5ly
Two-Tone: Zone A (Seat/Sides) 6.0ly Zone B (Kick Plate) 2ly

Dimensions:

W: 54.5
D: 29
H: 39.5
SH: 24
SD: 20

Power Upgrades (Inside use only)
[Add to List Price](#)

+\$390 Salt®
+\$390 Pepper®

BYRNE

**Please specify LH sit, RH sit or both LH/RH sit for the power location(s)*

Elevate Work Double	Yardage	COM	A	B	C	D	E	F	G	H	I
Upholstered	6.5	\$4,393	\$4,609	\$4,718	\$4,869	\$5,021	\$5,173	\$5,389	\$5,606	\$6,011	\$6,357

*If the textiles used in multi-zoning are different grades, use price of the higher grade level.

WORK HEIGHT ELEVATE - INSIDE 45

Designed by POPULOUS

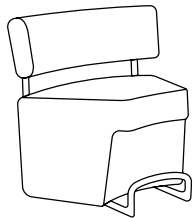

Model: Elevate Inside 45
Weight: Approx 75 lbs
Material: Upholstered
Wood: Marine-grade Plywood
Leg Type: Leveling Glides
Glide Finish: Black
Material: Metal
Powder Coat: Standard 8 colors

Fabric Required:

Solid: 4ly
Two-Tone: Zone A (Seat/Sides) 3.5ly Zone B (Kick Plate) 1ly

Dimensions:

W: 38
D: 29
H: 39.5
SH: 24
SD: 20

Power Upgrades (Inside use only)
[Add to List Price](#)

+\$390 Salt®
+\$390 Pepper®

BYRNE

**Please specify LH sit, RH sit or both LH/RH sit for the power location(s)*

Elevate Work Inside 45	Yardage	COM	A	B	C	D	E	F	G	H	I
Upholstered	4	\$2,902	\$3,035	\$3,102	\$3,195	\$3,289	\$3,382	\$3,515	\$3,649	\$3,897	\$4,111

*If the textiles used in multi-zoning are different grades, use price of the higher grade level.

WORK HEIGHT ELEVATE - OUTSIDE 45

Designed by POPULOUS

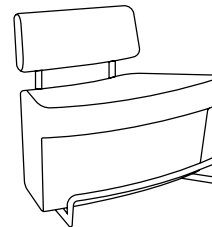

Model: Elevate Outside 45
Weight: Approx 120 lbs
Material: Upholstered
Wood: Marine-grade Plywood
Leg Type: Leveling Glides
Glide Finish: Black
Material: Metal
Powder Coat: Standard 8 colors

Fabric Required:

Solid: 4.5ly
Two-Tone: Zone A (Seat/Sides) 4ly Zone B (Kick Plate) 1ly

Dimensions:

W: 55.5
D: 40
H: 39.5
SH: 24
SD: 20

Power Upgrades (Inside use only)
[Add to List Price](#)

+\$390 Salt®
+\$390 Pepper®

BYRNE

**Please specify LH sit, RH sit or both LH/RH sit for the power location(s)*

Elevate Work Outside 45	Yardage	COM	A	B	C	D	E	F	G	H	I
Upholstered	4.5	\$3,229	\$3,379	\$3,454	\$3,559	\$3,664	\$3,769	\$3,919	\$4,069	\$4,349	\$4,589

*If the textiles used in multi-zoning are different grades, use price of the higher grade level.

WORK HEIGHT ELEVATE - BACKLESS

Designed by POPULOUS

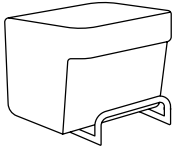

Model: Elevate Backless
Weight: Approx 44 lbs
Material: Upholstered
Wood: Marine-grade Plywood
Leg Type: Leveling Glides
Glide Finish: Black
Material: Metal
Powder Coat: Standard 8 colors

Dimensions:
 W: 27
 D: 29
 H: 24
 SH: 24

Power Upgrades (Inside use only)
[Add to List Price](#)

+\$390 Salt®
+\$390 Pepper®

BYRNE

**Please specify LH sit, RH sit or both LH/RH sit for the power location(s)*

Fabric Required:

Solid: 3ly
Two-Tone: Zone A (Seat/Sides) 3ly Zone B (Kick Plate) 1ly

Elevate Work Backless	Yardage	COM	A	B	C	D	E	F	G	H	I
Upholstered	3	\$1,936	\$2,036	\$2,086	\$2,156	\$2,226	\$2,296	\$2,396	\$2,496	\$2,683	\$2,843

*If the textiles used in multi-zoning are different grades, use price of the higher grade level.

WORK HEIGHT ELEVATE - CAFE TABLE

Designed by POPULOUS

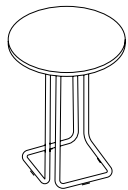

Model: Elevate Work Table
Weight: Approx 50 lbs
Table Top: Powder coated MDF
Leg Type: Leveling Glides
Glide Finish: Black
Material: Metal
Powder Coat: Standard 8 colors

Dimensions:
 DIA: 30
 H: 34.5

List Price \$1,195



WORK HEIGHT ELEVATE - COFFEE TABLE

Designed by POPULOUS



Model: Elevate Coffee Table
Weight: Approx 45 lbs
Table Top: Powder coated MDF
Leg Type: Leveling Glides
Glide Finish: Black
Material: Metal
Powder Coat: Standard 8 colors

Dimensions: **List Price \$1,125**

DIA: 24
 H: 24.5

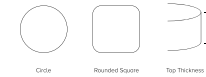

WORK HEIGHT ELEVATE - WORK TABLE

Designed by POPULOUS

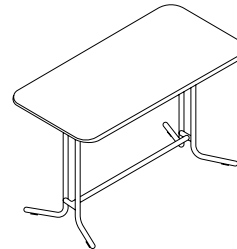

Model: Elevate Work Table
Weight: Approx 110 lbs
Table Top: Powder coated MDF
Leg Type: Leveling Glides
Glide Finish: Black
Material: Metal
Powder Coat: Standard 8 colors

Dimensions:
 TOP: 60 x 30
 H: 34.5

List Price \$2,160

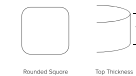

LOUNGE HEIGHT ELEVATE - SINGLE

Designed by POPULOUS

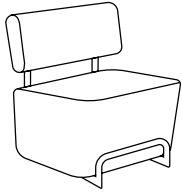

Model: Elevate Single
Weight: 55 lbs
Material: Upholstered
Wood: Marine-grade Plywood
Leg Type: Leveling Glides
Glide Finish: Black
Material: Metal
Powder Coat: Standard 8 colors

Dimensions:
W: 27
D: 29
H: 33.5
SH: 18
SD: 20

Power Upgrades (Inside use only)
[Add to List Price](#)

+\$390 Salt®
+\$390 Pepper®

BYRNE

**Please specify LH sit, RH sit or both LH/RH sit for the power location(s)*

Fabric Required:

Solid: 3.5ly
Two-Tone: Zone A (Seat/Sides) 3ly Zone B (Kick Plate) 1ly

Elevate Lounge Single	Yardage	COM	A	B	C	D	E	F	G	H	I
Upholstered	3.5	\$2,251	\$2,368	\$2,426	\$2,508	\$2,589	\$2,671	\$2,788	\$2,904	\$3,122	\$3,309

*If the textiles used in multi-zoning are different grades, use price of the higher grade level.

LOUNGE HEIGHT ELEVATE - DOUBLE

Designed by POPULOUS

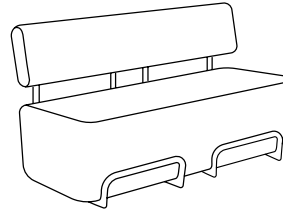

Model: Elevate Double
Weight: 110 lbs
Material: Upholstered
Wood: Marine-grade Plywood
Leg Type: Leveling Glides
Glide Finish: Black
Material: Metal
Powder Coat: Standard 8 colors

Dimensions:
W: 54.5
D: 29
H: 33.5
SH: 18
SD: 20

Power Upgrades (Inside use only)
[Add to List Price](#)

+\$390 Salt®
+\$390 Pepper®

BYRNE

**Please specify LH sit, RH sit or both LH/RH sit for the power location(s)*

Fabric Required:

Solid: 6ly
Two-Tone: Zone A (Seat/Sides) 5.5ly Zone B (Kick Plate) 1ly

Elevate Lounge Double	Yardage	COM	A	B	C	D	E	F	G	H	I
Upholstered	6	\$3,830	\$4,030	\$4,130	\$4,270	\$4,410	\$4,550	\$4,750	\$4,950	\$5,323	\$5,643

*If the textiles used in multi-zoning are different grades, use price of the higher grade level.

LOUNGE HEIGHT ELEVATE - INSIDE 45

Designed by POPULOUS

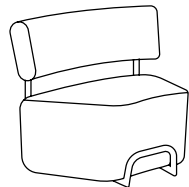

Model: Elevate Inside 45
Weight: Approx 65 lbs
Material: Upholstered
Wood: Marine-grade Plywood
Leg Type: Leveling Glides
Glide Finish: Black
Material: Metal
Powder Coat: Standard 8 colors

Dimensions:
W: 38
D: 29
H: 33.5
SH: 18
SD: 20

Power Upgrades (Inside use only)
[Add to List Price](#)

+\$390 Salt®
+\$390 Pepper®

BYRNE

**Please specify LH sit, RH sit or both LH/RH sit for the power location(s)*

Fabric Required:

Solid: 4ly
Two-Tone: Zone A (Seat/Sides) 3.5ly Zone B (Kick Plate) 1ly

Elevate Lounge Inside 45	Yardage	COM	A	B	C	D	E	F	G	H	I
Upholstered	4	\$2,530	\$2,663	\$2,730	\$2,823	\$2,917	\$3,010	\$3,143	\$3,277	\$3,525	\$3,739

*If the textiles used in multi-zoning are different grades, use price of the higher grade level.

LOUNGE HEIGHT ELEVATE - OUTSIDE 45

Designed by POPULOUS

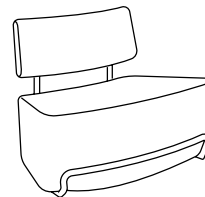

Model: Elevate Outside 45
Weight: Approx 105 lbs
Material: Upholstered
Wood: Marine-grade Plywood
Leg Type: Leveling Glides
Glide Finish: Black
Material: Metal
Powder Coat: Standard 8 colors

Dimensions:
W: 55.5
D: 40
H: 33.5
SH: 18
SD: 20

Power Upgrades (Inside use only)
[Add to List Price](#)

+\$390 Salt®
+\$390 Pepper®

BYRNE

**Please specify LH sit, RH sit or both LH/RH sit for the power location(s)*

Fabric Required:

Solid: 4ly
Two-Tone: Zone A (Seat/Sides) 3ly Zone B (Kick Plate) 1ly

Elevate Lounge Outside 45	Yardage	COM	A	B	C	D	E	F	G	H	I
Upholstered	4	\$2,815	\$2,948	\$3,015	\$3,108	\$3,202	\$3,295	\$3,428	\$3,562	\$3,810	\$4,024

*If the textiles used in multi-zoning are different grades, use price of the higher grade level.

LOUNGE HEIGHT ELEVATE - BACKLESS

Designed by POPULOUS

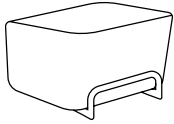

Model: Elevate Backless
Weight: Approx 38 lbs
Material: Upholstered
Wood: Marine-grade Plywood
Leg Type: Leveling Glides
Glide Finish: Black
Material: Metal
Powder Coat: Standard 8 colors

Dimensions:
 W: 27
 D: 29
 H: 18
 SH: 18

Power Upgrades (Inside use only)
[Add to List Price](#)

+\$390 Salt®
+\$390 Pepper®

BYRNE

**Please specify LH sit, RH sit or both
 LH/RH sit for the power location(s)*

Fabric Required:

Solid: 3ly

Two-Tone: Zone A (Seat/Sides) 2.5ly Zone B (Kick Plate) 1ly

Elevate Lounge Backless	Yardage	COM	A	B	C	D	E	F	G	H	I
Upholstered	3	\$1,606	\$1,706	\$1,756	\$1,826	\$1,896	\$1,966	\$2,066	\$2,166	\$2,353	\$2,513

*If the textiles used in multi-zoning are different grades, use price of the higher grade level.

LOUNGE HEIGHT ELEVATE - COFFEE TABLE

Designed by POPULOUS



Model: Elevate Coffee Table
Weight: Approx 40 lbs
Table Top: Powder coated MDF
Leg Type: Leveling Glides
Glide Finish: Black
Material: Metal
Powder Coat: Standard 8 colors

Dimensions:
 DIA: 24
 H: 17.5

List Price \$1,055



LOUNGE HEIGHT ELEVATE - CAFE TABLE

Designed by POPULOUS

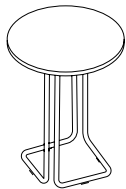

Model: Elevate Work Table
Weight: 45 lbs
Table Top: Powder coated MDF
Leg Type: Leveling Glides
Glide Finish: Black
Material: Metal
Powder Coat: Standard 8 colors

Dimensions:
 DIA: 30
 H: 29.5

List Price \$1,160



LOUNGE HEIGHT ELEVATE - WORK TABLE

Designed by POPULOUS

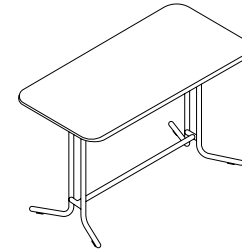

Model: Elevate Work Table
Weight: Approx 105 lbs
Table Top: Powder coated MDF
Leg Type: Leveling Glides
Glide Finish: Black
Material: Metal
Powder Coat: Standard 8 colors

Dimensions:
 TOP: 60 x 30
 H: 29.5

List Price \$2,130

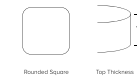

ELEVATE - PLANTER

Designed by POPULOUS



Model: Elevate Planter
Weight: Approx 75 lbs
Material: Upholstered
Wood: Marine-grade Plywood
Leg Type: Leveling Glides
Glide Finish: Black
Material: Metal
Powder Coat: Standard 8 colors

Dimensions:
W: 27
D: 18.5
H: 35

Upgrades
[Add to List Price](#)
+\$00 Drain/Tube (Outdoor)

Fabric Required: Solid: 3ly

Elements Planter	Yardage	COM	A	B	C	D	E	F	G	H	I
Upholstered	3	\$1,651	\$1,751	\$1,801	\$1,871	\$1,941	\$2,011	\$2,111	\$2,211	\$2,398	\$2,558

ELEVATE - UPH ARMREST

Designed by POPULOUS

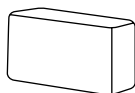

Model: Elevate Armrest
Weight: Approx
Material: Upholstered
Wood: Marine-grade Plywood
Leg Type: Leveling Glides
Glide Finish: Black
Material: Metal
Powder Coat: Standard 8 colors

Dimensions:
W: 6.5
D: 16
H: 9.5

Power Upgrades (Inside use only)
[Add to List Price](#)

+\$390 Salt®
+\$390 Pepper®

BYRNE

**Please specify single or double power option. Power is stacked.*



Table Upgrade
[Add to List Price](#)

+\$115 Powder Coated MDF

Fabric Required: Solid: .5ly

Elements 45 Corner	Yardage	COM	A	B	C	D	E	F	G	H	I
Upholstered	0.5	\$455	\$472	\$480	\$492	\$503	\$515	\$532	\$548	\$579	\$606

ELEVATE - DRINK RAIL

Designed by POPULOUS

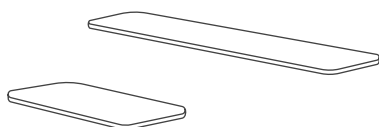

Model: Elevate Drink Rail
Weight: Approx
Material: Powder Coated MDF
Powder Coat: White
***Call for custom finish*

List Price \$780
Single Drink Rail

Dimensions:
W: 26.5
D: 10
H: 1

List Price \$1,255
Double Drink Rail

Dimensions:
W: 54
D: 10
H: 1

ELEVATE - TABLE ACCESSORIES

Designed by POPULOUS

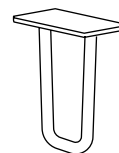

Model: Elevate End Arm
Weight: Approx
Table Top: Powder coated MDF
Leg Type: Leveling Glides
Glide Finish: Black
Material: Metal
Powder Coat: Standard 8 colors

Top Dimensions:
W: 11
L: 15

List Price \$550

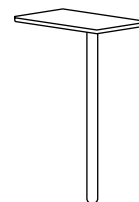

Model: Elevate Wedge
Weight: Approx
Table Top: Powder coated MDF
Leg Type: Leveling Glides
Glide Finish: Black
Material: Metal
Powder Coat: Standard 8 colors

Top Dimensions:
W: 11
L: 15

List Price \$350

Upgrades
[Add to List Price](#)

+\$100 Swivel

ELEVATE - GANGING

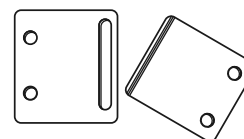

Model: Elements Ganging
Weight: Approx .5 lbs.
Material: Powder Coated Metal
Color: Black

List Price \$160

**Sold in set (Male/Female)*

Approved Outdoor Materials

Vinyl Grade B - Mayer - All Seasons
Vinyl Grade B - Omnova - Colorguard
Vinyl Grade C - Spradling - Silvertex Neo
Woven Grade B - Sunbrella - Nature Haze
Woven Grade E - Sunbrella - Canvas Seasalt

Pre-selected vinyl and woven materials

HOW TO SPEC ARM RESTS

1. Select Your Unit

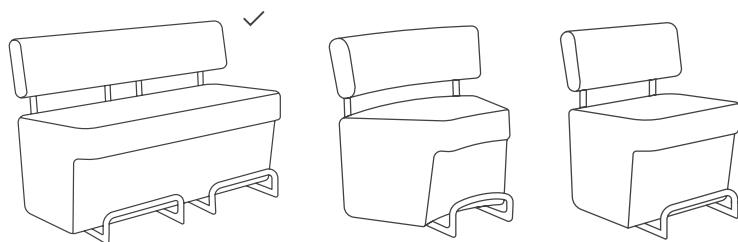

2. Determine Arm Side Needed

*Left or Right Hand Sitting

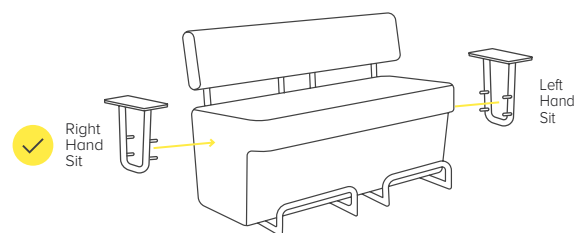

3. Installation

Table and Drink Rail metal supports will be factory-installed. Tops will require field installation.

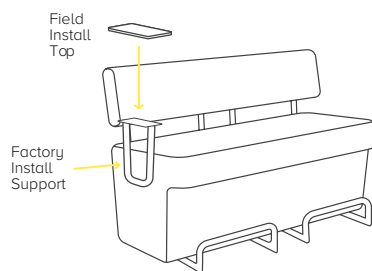

Things To Note

1. Backless units can only receive "End Arm Tables".
2. End Arm Tables can be specified on all units. For multiple groupings, End Arm Tables should bookend the complete set. They are not designed to wedge between units.
3. Wedge, Wedge Swivel, UPH Arm, and UPH Arm w/Table can only be used between two units - these tables are not designed to visually bookend a unit or grouping.
4. Purchase orders must specify what product receives the attached arm rest / wedge table. See below.

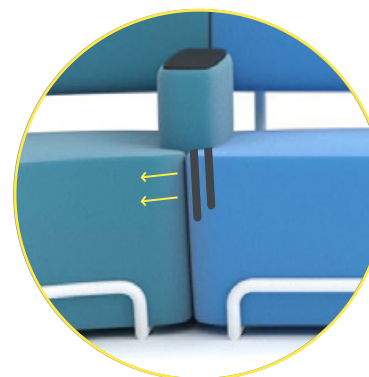
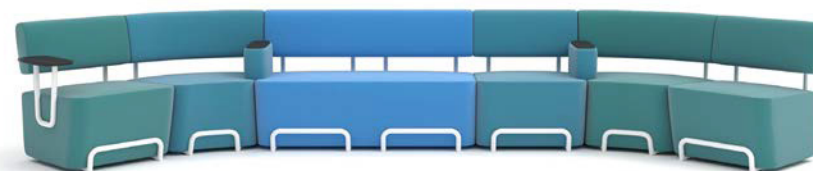

Example:

Inside 45
With Left Hand Sit
Upholstered Arm

ELEVATE ZONING

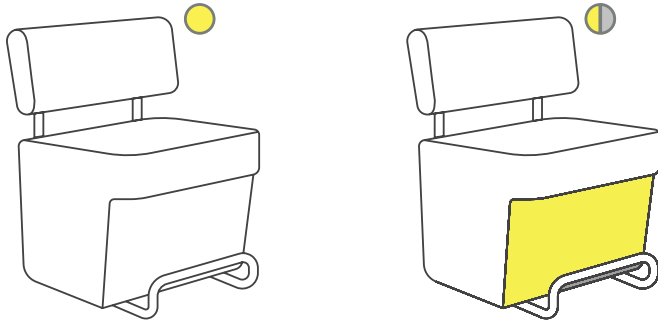

 **SOLID**

 **TWO TONE**
FABRIC 1
 SEAT / SIDES / BACK
FABRIC 2
 KICK PANEL

Approved Outdoor Materials

Vinyl Grade B - Mayer - All Seasons
 Vinyl Grade B - Omnova - Colorguard
 Vinyl Grade C - Spradling - Silvertex Neo
 Woven Grade B - Sunbrella - Nature Haze
 Woven Grade E - Sunbrella - Canvas Seasalt

Pre-selected vinyl and woven materials

BOTHY

Designed by SIXINCH® USA

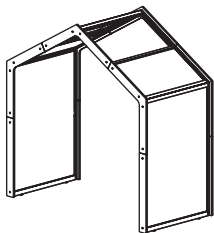

Model: Bothy
Frame: Metal
Frame Finish: Powder Coat
Inserts: PET Felt
5" Fascia: Wood / HPL

Dimensions:
 W: 105"
 D: 51"
 H: 104"

List Price \$13,500

Upgrades
[Add to List Price](#)

+\$400 Casters (adds 1.2")
+Call Custom

BOTHY ZONING

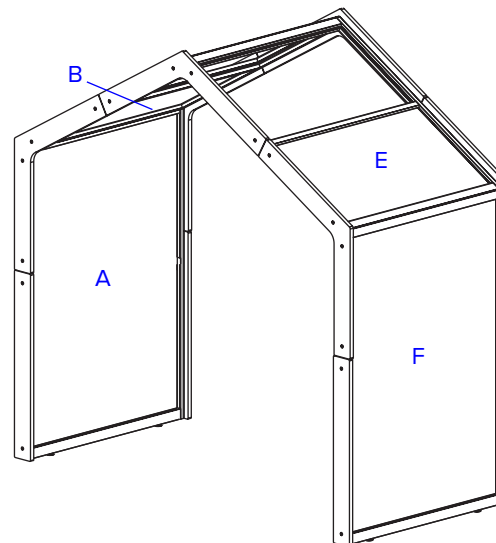

SOLID PET PANELS

CUT-IN DESIGN PANELS

ZONE A,B,E,F

STANDARD PET COLORS

*White Noise, Smoke, Cast Iron
 Fossil, Sonic Blue, Moss, Latte*

STANDARD POWDER COAT COLORS

*White, Black, Copper, Blush, Honey
 Seafoam, Pigeon Blue, Signal Grey*

STANDARD 5" FASCIA HPL COLORS

White, Grey, Custom (Call)

PET FELT OPTIONS PRICE PER PANEL TO ADD CUT-IN DESIGNS + \$100 TO LIST

GRASS

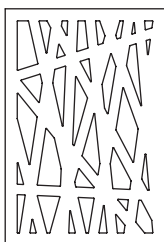

1/2 HORIZON

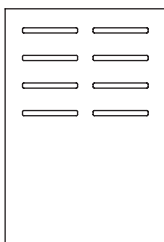

HORIZON

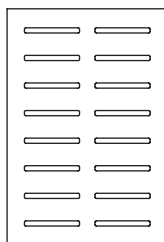

GEARS

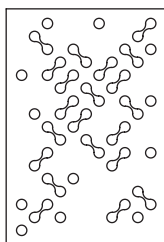

BUBBLE TOPPER

Designed by SIXINCH® USA

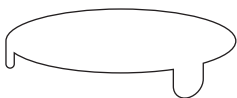

Model: Bubble Topper
Weight: Approx 5 lbs.
Material: Steel
Finish: Powder Coat

Dimensions:
W: 18.25
D: 18.25

List Price \$283

TAUKO - COFFEE



Designed by Mac Stopa



Model: Tauko Side Table
Weight: Approx
Base: Metal+Wood
Table Material: SMARTMATTE 3DL
Table Finish: White, Grey, Black
Shape: Round, Rounded Square, Square
Metal Finish: Powder Coat
Leg Species: Beech, Oak
Leg Finish: Clear Stain

Dimensions:
W: 24
D: 24
H: 20

List Price \$1,680

Upgrades
[Add to List Price](#)

+\$58 Leg Color Stain

Note: Legs imported, Tops made in USA

LEVEL TOPPER

Designed by SIXINCH® USA



Model: Level Topper
Weight: Approx 5 lbs.
Material: Metal
Finish: Powder Coated

Dimensions:
W: 15
D: 18.5
H: 3.5

List Price \$280

TAUKO - STANDARD DINING



Designed by Mac Stopa



Model: Tauko Coffee Table
Weight: Approx
Base: Metal+Wood
Table Material: SMARTMATTE 3DL
Table Finish: White, Grey, Black
Shape: Round, Rounded Square, Square
Metal Finish: Powder Coat
Leg Species: Beech, Oak
Leg Finish: Clear Stain

Dimensions:
W: 32
D: 32
H: 28.5

List Price \$2,034

Upgrades
[Add to List Price](#)

+\$58 Leg Color Stain

Note: Legs imported, Tops made in USA

TAUKO - MODULAR



Designed by Mac Stopa



Model: Tauko Modular Table
Weight: Approx
Base: Metal+Wood
Table Material: SMARTMATTE 3DL
Table Finish: White, Grey, Black
Metal Finish: Powder Coat
Leg Species: Beech, Oak
Leg Finish: Clear Stain

Dimensions:
W: 27
D: 22.5
H: 28.5

List Price \$1,828

Upgrades
[Add to List Price](#)

+\$58 Leg Color Stain

Note: Legs imported, Tops made in USA

TAUKO - CONFERENCE



Designed by Mac Stopa

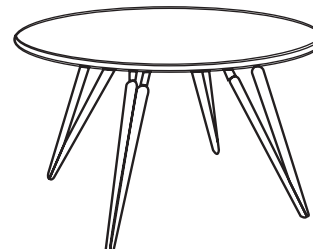

Model: Tauko Conference Table
Weight: Approx
Base: Metal+Wood
Table Material: SMARTMATTE 3DL
Table Finish: White, Grey, Black
Shape: Round, Rounded Square, Square
Metal Finish: Powder Coat
Leg Species: Beech, Oak
Leg Finish: Clear Stain

Dimensions:
W: 48
D: 48
H: 28.5

List Price \$3,542

Upgrades
[Add to List Price](#)

+\$58 Leg Color Stain

Note: Legs imported, Tops made in USA

Import / 10-12 Week Lead Time

MIMMO STIWOOD - ROUND PEDESTAL

Designed by Stiwood

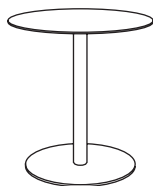

Model: Mimmo Stiwood - Round Pedestal
Weight: Approx
Table Material: SMARTMATTE 3DL
Table Finish: White, Grey, Black
Table Options: Round, Square, Rounded Square
Table Thickness: 1"
Base: Metal
Base Finish: Chrome

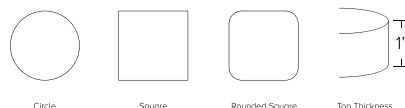

Note: Legs imported, Tops made in USA

Coffee - 17.5" Height				Side - 22" Height				Dining - 31.5" Height			
Table Top Shape				Table Top Shape				Table Top Shape			
Table Top Size	Square Top	Rounded Square Top	Round Top	Table Top Size	Square Top	Rounded Square Top	Round Top	Table Top Size	Square Top	Rounded Square Top	Circle Top
20" x 20"	\$946	\$946		20" x 20"	\$949	\$949	\$949	20" x 20"	\$1,018	\$1,018	\$1,018
24" x 24"	\$1087	\$1087		24" x 24"	\$1098	\$1098	\$1098	24" x 24"	\$1,168	\$1,168	\$1,168
20" Diameter			\$946	20" Diameter			\$949	20" Diameter			\$1,018
24" Diameter			\$1087	24" Diameter			\$1098	24" Diameter			\$1,168
28" Diameter				28" Diameter			\$1,106	28" Diameter			\$1,167

MIMMO STIWOOD - 4 STAR

Designed by Stiwood



Model: Mimmo Stiwood - 4 Star
Weight: Approx
Table Material: SMARTMATTE 3DL
Table Finish: White, Grey, Black
Table Options: Round, Square, Rounded Square
Table Thickness: 1"
Base: Metal
Base Finish: Chrome

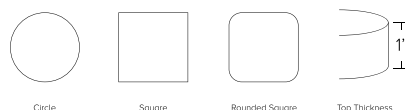

Note: Legs imported, Tops made in USA

Coffee - 17.5" Height				Side - 22" Height				Dining - 31.5" Height			
Table Top Shape				Table Top Shape				Table Top Shape			
Table Top Size	Square Top	Rounded Square Top	Round Top	Table Top Size	Square Top	Rounded Square Top	Round Top	Table Top Size	Square Top	Rounded Square Top	Round Top
20" x 20"	\$1,142	\$1,142		20" x 20"	\$855	\$855		20" x 20"	\$924	\$924	
24" x 24"	\$1,283	\$1,283		24" x 24"	\$975	\$975		24" x 24"	\$1,074	\$1,074	
20" Diameter			\$1,142	20" Diameter			\$855	20" Diameter			\$924
24" Diameter			\$1,283	24" Diameter			\$975	24" Diameter			\$1,074
				28" Diameter			\$983	28" Diameter			\$1,073

 Import / 10-12 Week Lead Time

MIMMO STIWOOD - 4 LEG WOOD

Designed by Stiwood



Model: Mimmo Stiwood - 4 Leg Wood
Weight: Approx
Table Material: SMARTMATTE 3DL
Table Finish: White, Grey, Black
Table Options: Round, Square, Rounded Square
Table Thickness: 1"
Base: Wood
Base Finish: Walnut, Oak, Ash

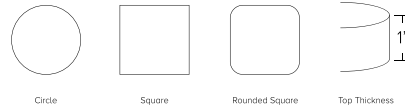

Note: Legs imported, Tops made in USA

Coffee - 17.5" Height				Side - 22" Height			
Table Top Size	Square Top	Rounded Square Top	Round Top	Table Top Size	Square Top	Rounded Square Top	Round Top
20" x 20"	\$751	\$751		20" x 20"	\$770	\$770	
24" x 24"	\$893	\$893		24" x 24"	\$892	\$892	
20" Diameter			\$751	20" Diameter			\$770
24" Diameter			\$893	24" Diameter			\$892

MIMMO NOWY STYL - 4 STAR CRUZO

Designed by Nowy Styl

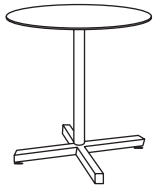

Model: Mimmo Nowy Styl - 4 Star
Weight: Approx
Table Material: SMARTMATTE 3DL
Table Finish: White, Grey, Black
Table Options: Round, Square, Rounded Square
Table Thickness: 1"
Base: Metal
Base Finish: Chrome

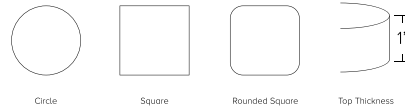

Note: Legs imported, Tops made in USA

Dining - 29" Height		Table Top Shape		
Table Top Size	Style	Square Top	Rounded Square Top	Round Top
28" x 28"	600	\$1,032	\$1,032	
32" x 32"	800	\$1,591	\$1,591	
36" x 36"	800	\$1,749	\$1,749	
28" Diameter	600			\$1,032
32" Diameter	800			\$1,591
36" Diameter	800			\$1,749

Dining - 32" Height		Table Top Shape		
Table Top Size	Style	Square Top	Rounded Square Top	Round Top
40" x 40"	1000	\$1,840	\$1,840	
40" Diameter	1000			\$1,840

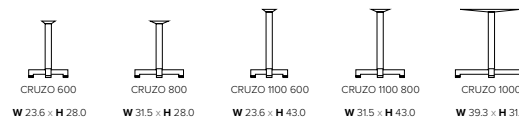

Bar - 44" Height		Table Top Shape		
Table Top Size	Style	Square Top	Rounded Square Top	Round Top
28" x 28"	1100 600	\$1,409	\$1,409	
28" x 28"	1100 800	\$1,446	\$1,446	
32" x 32"	1100 600	\$1,302	\$1,302	
32" x 32"	1100 800	1,655	1,655	
36" x 36"	1100 800	\$1,767	\$1,767	
28" Diameter	1100 600			\$1,409
32" Diameter	1100 600			\$1,302
28" Diameter	1100 800			\$1,446
32" Diameter	1100 800			\$1,655
36" Diameter	1100 800			\$1,767

Import / 10-12 Week Lead Time

PLAIN - COFFEE

Designed by Stiwood



Model: Plain - Coffee 31"
Weight: Approx 31 lbs.
Base: Wood+Metal
Leg Species: Ash
Leg Finish: Walnut, Oak, White, Black
Table Material: SMARTMATTE 3DL
Table Finish: White, Grey, Black
Table Shape: Rectangle
Table Thickness: 1"
Metal Frame: Powder Coated White

Note: Legs imported, Tops made in USA

Dimensions: **List Price \$1,498**

W: 31.5
D: 31.5
H: 14

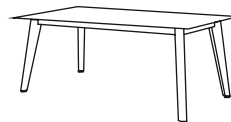

Model: Plain - Coffee 47"
Weight: Approx
Base: Wood+Metal
Leg Species: Ash
Leg Finish: Walnut, Oak, White, Black
Table Material: SMARTMATTE 3DL
Table Finish: White, Grey, Black
Table Shape: Rectangle
Table Thickness: 1"
Metal Frame: Powder Coated White

Note: Legs imported, Tops made in USA

Dimensions: **List Price \$1,653**

W: 47.5
D: 31.5
H: 14

PLAIN - WORK

Designed by Stiwood

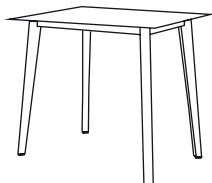

Model: Plain - Work 31"
Weight: Approx
Base: Wood+Metal
Leg Species: Ash
Leg Finish: Walnut, Oak, White, Black
Table Material: SMARTMATTE 3DL
Table Finish: White, Grey, Black
Table Shape: Rectangle
Table Thickness: 1"
Metal Frame: Powder Coated White

Note: Legs imported, Tops made in USA

Dimensions: **List Price \$1,631**

W: 31.5
D: 31.5
H: 30

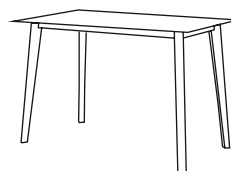

Model: Plain - Work 47"
Weight: Approx
Base: Wood+Metal
Leg Species: Ash
Leg Finish: Walnut, Oak, White, Black
Table Material: SMARTMATTE 3DL
Table Finish: White, Grey, Black
Table Shape: Rectangle
Table Thickness: 1"
Metal Frame: Powder Coated White

Note: Legs imported, Tops made in USA

Dimensions: **List Price \$1,786**

W: 47.5
D: 31.5
H: 30

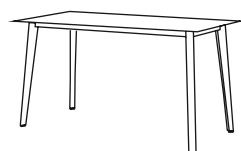

Model: Plain - Work 63"
Weight: Approx
Base: Wood+Metal
Leg Species: Ash
Leg Finish: Walnut, Oak, White, Black
Table Material: SMARTMATTE 3DL
Table Finish: White, Grey, Black
Table Shape: Rectangle
Table Thickness: 1"
Metal Frame: Powder Coated White

Note: Legs imported, Tops made in USA

Dimensions: **List Price \$2,547**

W: 63
D: 31.5
H: 30

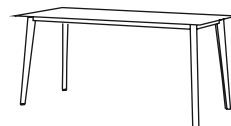

Model: Plain - Work 71"
Weight: Approx
Base: Wood+Metal
Leg Species: Ash
Leg Finish: Walnut, Oak, White, Black
Table Material: SMARTMATTE 3DL
Table Finish: White, Grey, Black
Table Shape: Rectangle
Table Thickness: 1"
Metal Frame: Powder Coated White

Note: Legs imported, Tops made in USA

Dimensions: **List Price \$2,593**

W: 71
D: 31.5
H: 30

PLAIN - BAR

Designed by Stiwood

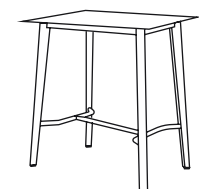

Model: Plain - Bar 31"
Weight: Approx
Base: Wood+Metal
Leg Species: Ash
Leg Finish: Walnut, Oak, White, Black
Table Material: SMARTMATTE 3DL
Table Finish: White, Grey, Black
Table Shape: Rectangle
Table Thickness: 1"
Metal Frame: Powder Coated White
Foot Rest: Chrome

Note: Legs imported, Tops made in USA

Dimensions: **List Price \$2,026**

W: 31.5
D: 31.5
H: 41.5

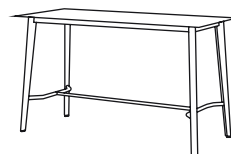

Model: Plain - Bar 71"
Weight: Approx
Base: Wood+Metal
Leg Species: Ash
Leg Finish: Walnut, Oak, White, Black
Table Material: SMARTMATTE 3DL
Table Finish: White, Grey, Black
Table Shape: Rectangle
Table Thickness: 1"
Metal Frame: Powder Coated White
Foot Rest: Chrome

Note: Legs imported, Tops made in USA

Dimensions: **List Price \$3,016**

W: 71
D: 31.5
H: 41.5

 **Import / 10-12 Week Lead Time**

BOZ

Designed by SIXINCH® USA

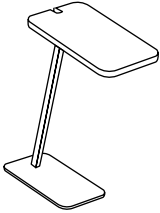

Model: Boz Side Table
Weight: Approx 28 lbs.
Base: Metal
Metal Finish: Powder Coat
Powder Coat Colors: White, Black, Copper, Blush, Honey, Seafoam, Pigeon Blue, Signal Grey
Table Top: Acrylic Solid Surface
Solid Surface Colors: Black, White, Grey, Light Grey, Sand

Dimensions: **List Price \$977**
W: 12
D: 18
H: 25.5
Top:
W: 12
D: 18

TWIGGY

Designed by SIXINCH®

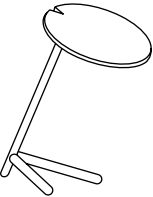

Model: Twiggy Side Table
Weight: Approx 20 lbs.
Base: Metal
Metal Finish: Powder Coat
Powder Coat Colors: White, Black, Copper, Blush, Honey, Seafoam, Pigeon Blue, Signal Grey
Table Top: Acrylic Solid Surface
Solid Surface Colors: Black, White, Grey, Light Grey, Sand

Dimensions: **List Price \$1,250**
W: 17
D: 16
H: 25.5
Top:
Dia: 16

LILY

Designed by SIXINCH® USA

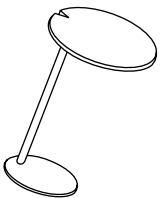

Model: Lily Side Table
Weight: Approx 28 lbs.
Base: Metal
Metal Finish: Powder Coat
Powder Coat Colors: White, Black, Copper, Blush, Honey, Seafoam, Pigeon Blue, Signal Grey
Table Top: Acrylic Solid Surface
Solid Surface Colors: Black, White, Grey, Light Grey, Sand

Dimensions: **List Price \$983**
W: 16
D: 16
H: 25.5
Top:
Dia: 16

 **Import / 10-12 Week Lead Time**

CIO

Designed by SIXINCH® USA



Model: CIO
Weight: Approx 27 lbs.
Leg/Support: 1" Russian Plywood+HPL
Leg/Support Finish: White
Material: PET Felt

Dimensions: **List Price \$2,372**
W: 42
D: 11
H: 68

TC

Designed by SIXINCH® USA

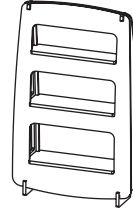

Model: TC
Weight: Approx 40 lbs.
Leg/Support: 1" Russian Plywood+HPL
Leg/Support Finish: White
Shelves: 1" Russian Plywood+HPL
Leg/Support Finish: White
Material: PET Felt

Dimensions: **List Price \$2,282**
W: 42
D: 11
H: 68

STAXX

Designed by SIXINCH® USA

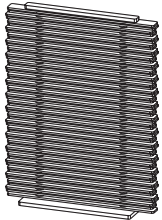

Model: STAXX
Weight: Approx 50 lbs.
Leg/Support: 1" Russian Plywood+HPL
Leg/Support Finish: White
Material: PET Felt
Standard Spacer Color: Fossil

Dimensions: **List Price \$2,790**
W: 42
D: 12
H: 56

STAXX SHORT

Designed by SIXINCH® USA

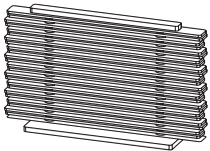

Model: STAXX Short
Weight: Approx 20 lbs.
Leg/Support: 1" Russian Plywood+HPL
Leg/Support Finish: White
Material: PET Felt
Standard Spacer Color: Fossil

Dimensions: **List Price \$1,125**
W: 42
D: 12
H: 15.5

ECHO 

Designed by STIWOOD

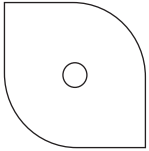

Model: Echo Wall Panels
Weight: Approx 2 lbs.
Material: Recycled Polyester Fiber w/Oak Stained (Ash) Wood Insert

Notes: Sold in sets of (2)

Dimensions: **List Price \$836**
 W: 24
 D: 1
 H: 24

SPROUT 

Designed by ALBA

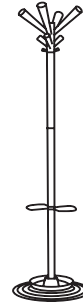

Model: Sprout Coat Hanger
Weight: Approx 19 lbs.
Material: Aluminum, Plastic
Finish: Clear+Silver Accents

Dimensions: **List Price \$390**
 W: 16.5
 H: 69

FOREST TALL 

Designed by STIWOOD

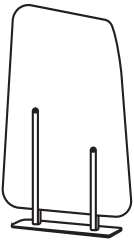

Model: Forest Tall Freestanding Divider
Weight: Approx 30 lbs.
Material: Recycled Polyester Fiber w/Oak Stained (Ash) Wood Legs / Supports

Dimensions: **List Price \$1,900**
 W: 33.5
 D: 11.5
 H: 65

FOREST SHORT 

Designed by STIWOOD

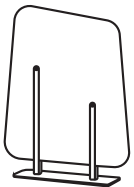

Model: Forest Short Freestanding Divider
Weight: Approx 24 lbs.
Material: Recycled Polyester Fiber w/Oak Stained (Ash) Wood Legs / Supports

Dimensions: **List Price \$1,700**
 W: 33.5
 D: 11.5
 H: 49.5

SOUND ABSORPTION

Freq [Hz]	α_s [-]
Frequency	Acoustic Absorption Coefficient Values
100	0.35
125	0.44
160	0.67
200	0.67
250	0.80
315	0.97
400	1.07
500	1.19
630	1.14
800	1.02
1000	1.00
1250	0.94
1600	0.91
2000	0.89
2500	0.85
3150	0.83
4000	0.80
5000	0.75

Sample Area: 11.47m²
 Reverberation Room Value: 161.3m³

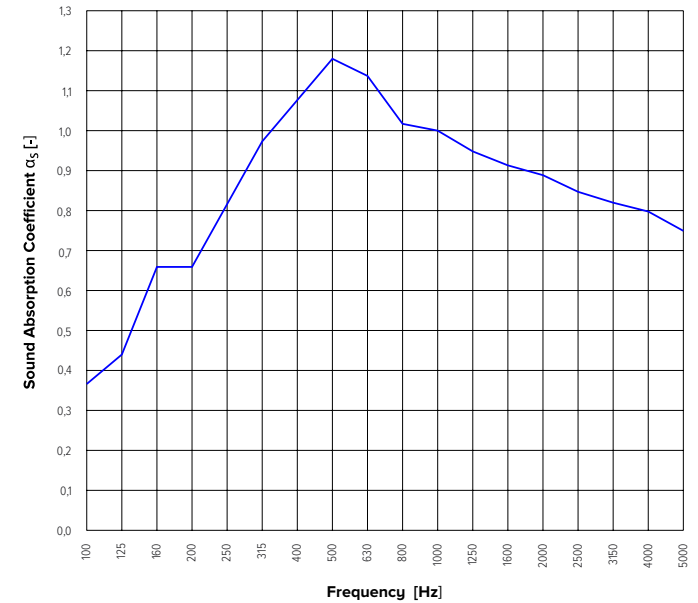

- List prices for FlexPlus™ coated products includes standard colors.
- Custom FlexPlus coating colors add \$500 net price per color match. Requires customer match approval.
- Upholstered products offered for graded-in fabric selections.

- All list prices are FOB: Factory Goshen, IN USA
- All product dimensions are shown in INCHES
- For finish options [SEE PAGE 82](#)

OPTIONS & ADD ONS

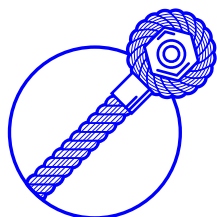

WIRE TETHERING KIT

Public installations might require anchoring furniture to the ground. This can be accomplished with a SIXINCH® tethering kit. One end of the strap is secured to the coated wood base while the other end can be secured to the floor of the installation site. The substrate connection will be determined by the site manager. Hardware is not included because the attachment method changes based on the type of material.

TETHER KIT-01
12" Braided Wire Cable
\$50 net per (1) 12" wire

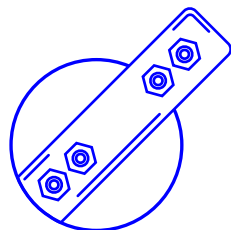

METAL GANGING BRACKET

When ordering SIXINCH® product for a high traffic indoor or outdoor application, decide whether to let them float free for ultimate flexibility, or join them together with our "Join Kit" so that they stay together at all times. We recommend 2 brackets for normal applications, 4 brackets if you have a creative group that rearranges frequently. This kit is field installed.

JOIN KIT-01
(2) connecting brackets - \$32 net
JOIN KIT-02
(12) connecting brackets - \$96 net

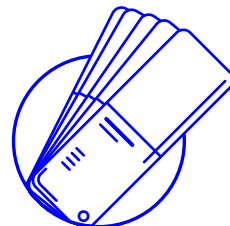

CUSTOM FLEXPLUS COLOR

List prices include your choice of one of our SIXINCH® standard colors. Custom colors can be mixed to your Pantone selection or matched to your color chip.

CUSTOM COLOR
\$500 net per color/order



ADDITIONAL WEIGHT

Weight can be added to FlexPlus™ coated pieces. Weight is added during the production stage and cannot be added after the piece is produced. Lead time for weighted products is our standard 8 weeks.

10lbs per piece - \$75 net
20lbs per piece - \$150 net
Max 30lbs per piece - \$225 net

FLEXPLUS™

Standard FlexPlus™



Custom colors available upon request.
Contact support@sixinch.us for more information.

POWDER COAT

Standard Offering

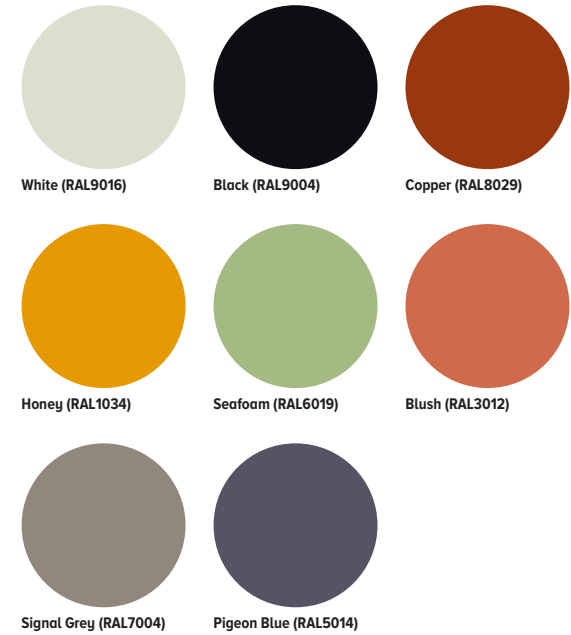

QUILTING

Standard & Custom Patterns

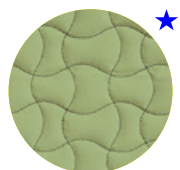

Cinch



Diamond

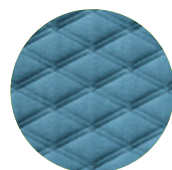

Diamond 2



Hex



Hourglass



Diamond Point



Circle



Diamond Wave

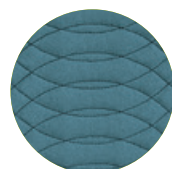

Wave

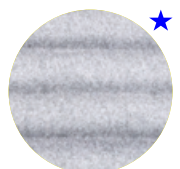

Channel

★ **STANDARD PATTERNS**

Additional patterns available upon request.
We are able to color match or provide contrast threading.
Contact support@sixinch.us for more information.

MOLDED PE

Standard Offering (Updated 2022)

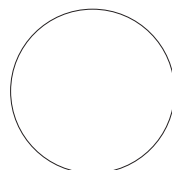

White (Translucent)

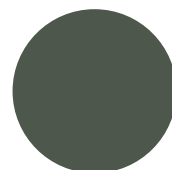

Olive

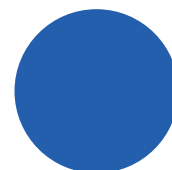

Blue

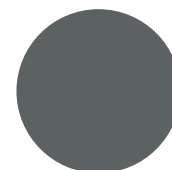

Grey

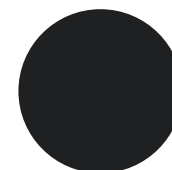

Black

CONTRASTING THREAD

Standard Offering

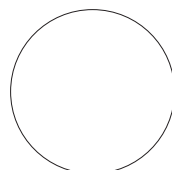

White

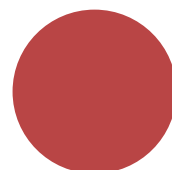

Shoe Red

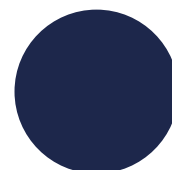

Navigator Blue

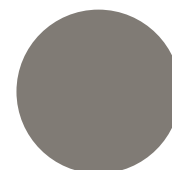

Pale Grey

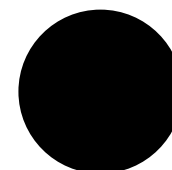

Black

WOOD

Standard Offering



Beech

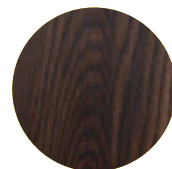

Maple - Walnut Finish



Maple - Clear Finish

SOLID SURFACE

Standard Offering

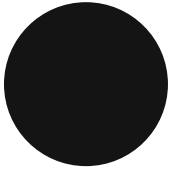

Black



White

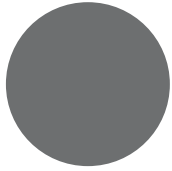

Grey

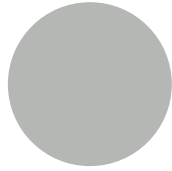

Light Grey

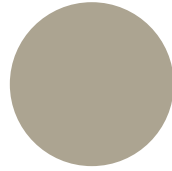

Sand

HPL

Standard Offering

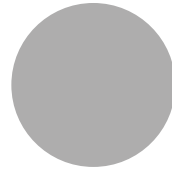

White

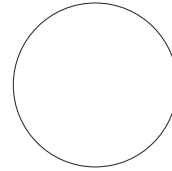

Black

PET FELT

Standard Offerings

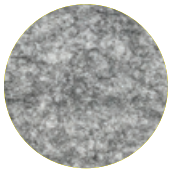

White Noise

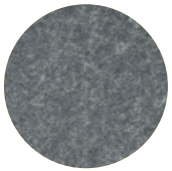

Cast Iron



Sonic



Latte

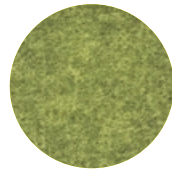

Moss

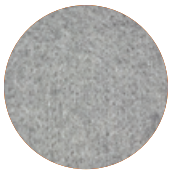

Smoke

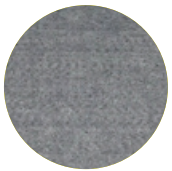

Fossil

IMPORTED

Brado, Alba, Stiwood

Basic

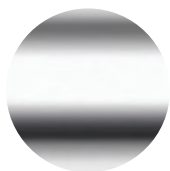

Metal Base
Chrome



Shell / Legs
Beech (Clear)



Quilting
*See Quilting Options



FlexPlus™
*See FlexPlus Colors

Scoop



Metal Base
Chrome



Wood Leg Species
Beech (Side chair) or Ash (Lounge)



Wood Finish / Stain Options
Clear, Walnut

Link



Shell Finish
Moss



Lemon



Black

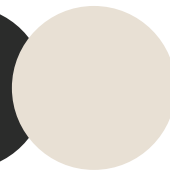

Oyster

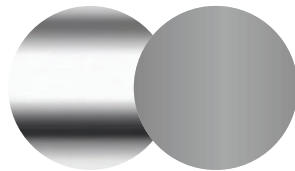

Metal Base
Chrome/Aluminum



Leg Finish
Beech (Clear)

Glo Lounge

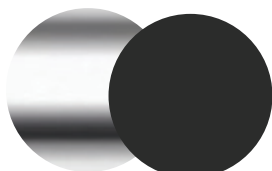

Metal Base
Chrome / Black



Wood Leg Species
Ash

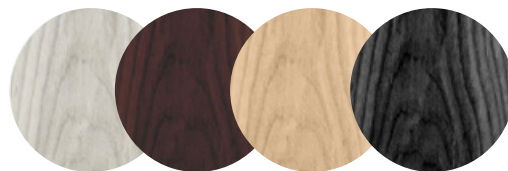

Wood Finish / Stain Options
Bleached, Walnut, Oak, Black

IMPORTED

Brado, Alba, Stiwood

Nuke

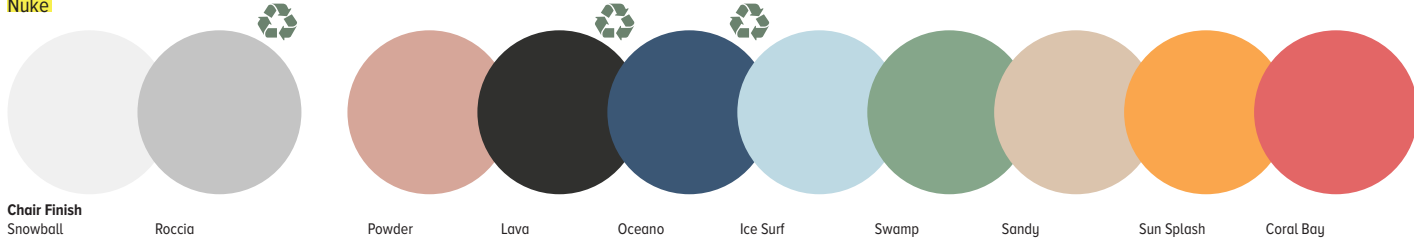

 100% Recycled

Forest

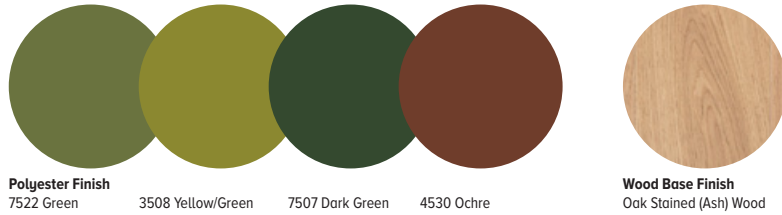

Polyester Finish
7522 Green 3508 Yellow/Green 7507 Dark Green 4530 Ochre

Wood Base Finish
Oak Stained (Ash) Wood

Echo



Shell Finishes
8009/1069 Neutral

3083/4066 Straw

3030/7020 Grass

6011/6007 Sky

4008/1069 Buckeye

Wood Base Finish
Oak Stained (Ash) Wood

IMPORTED

Tauko - Nowy Styl



Veneer (Shell Only)
Eco Nut



Oak



Ash



Wood Species (Shell / Leg)
Beech



Oak

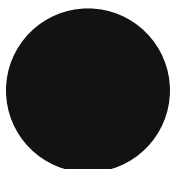

Metal (Metal Leg Support (Wood) / Metal Wire Legs)
RAL9005 Black

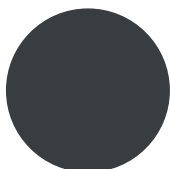

RAL7016 Anthracite



Chrome



RAL9016 Traffic White

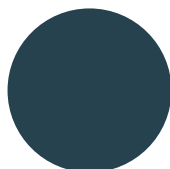

RAL5008 Grey Blue



RAL6012 Black Green

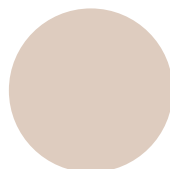

CS S 2005-Y60 Casmere NK

***Chrome only available for metal sled legs*



Wood Finish / Stain (Shell / Legs)
Clear

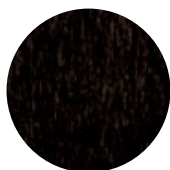

Black (w/grain)

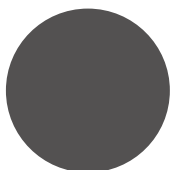

Dark Graphite

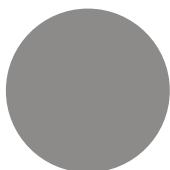

Slate

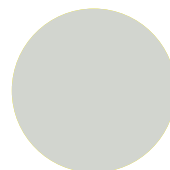

White

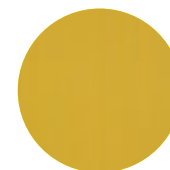

Saffron



Light Blue



Mint

GENERAL INFORMATION

SIXINCH designs, engineers and manufactures high quality upholstered products to exacting commercial design standards from a 200,000 square foot furniture manufacturing facility Goshen, Indiana. This is our headquarters. We live here. And we've been doing this for 40 years.

GUIDELINES FOR OUR UPHOLSTERY PROCESS

Customer Owned Materials and Leathers (COM or COL)

The COM or COL price shown on the price list is our price for applying a customer owned fabric to a certain furniture model. The following actions are what we need to do this successfully:

To receive and process customer owned fabric or leather into our manufacturing system, the fabric or leather must be shipped into our manufacturing plant clearly marked with the SIXINCH furniture purchase order to which the fabric or leather is to be applied. The customer is responsible to pay all freight costs for their materials. Cover material MUST be received into SIXINCH production before SIXINCH can release your order to manufacturing.

All COM/COL inquiries and shipment should be directed to:

SIXINCH® USA

ATTN: Customer Support

COM/COL Fabric Management

901 East Madison Street

Goshen, IN 46528

Fabric (indoor/outdoor) or Leather must be pre-approved as appropriate for the application requested (see Graded-In or COM/COL Fabric Selections and Approvals below).

- Fabric (indoor/outdoor) or Leather requirements for a specific job must be clearly defined in writing by the furniture purchaser. These written instructions for fabric or leather application must include details such as facing sides, railroading vs. non-railroading (up the roll), pattern matching, flaw tolerances, surface grading, etc. Orders including COM or COL will be applied based on SIXINCH common practices without clear fabric or leather application instructions or requirements accompanying the furniture purchase order.
- Yardage requirements shown in our price list assume fabric widths of 54". Any fabrics of narrower width will need to be evaluated for yardage requirement on a case by case basis. Yardage requirements shown are based on solid / non-alignment textiles. Any fabrics / textiles requiring alignment / matching must be evaluated on a case-by-case basis. Please contact SIXINCH USA Customer Service for pricing assistance in these cases.
- SIXINCH Customer Service will confirm material quantity requirements upon placement of your purchase order or upon your request for an upcoming order. Note: Any delay of COM shipping into SIXINCH could delay the finished product ship date.

- SIXINCH reserves the right to inspect and approve or reject all COM prior to production. At SIXINCH's discretion, COM will be rejected when deemed unsuitable because of durability, pattern, stretch or any other quality which inhibits application or detracts from the product's functional properties. SIXINCH assumes no responsibility for suitability or durability of COM.
- The customer will advise SIXINCH customer service as to disposition of any excess COM yardage by noting it on the purchase order. If not noted on the purchase order, SIXINCH will assume Customer does not want return of excess COM yardage and SIXINCH will seek to dispose of excess materials in any way it sees fit and without obligation for payment to Customer for the materials.
- If a customer has pending future orders that will use excess COM yardage, SIXINCH will store COM without charge to customer for a period of 30 days if noted on the customers purchase order. If excess yardage of COM remains after 30 days the materials will be deemed as orphaned and disposed of without obligation of payment to customer for the COM.

Outdoor Upholstered Furniture

- Fabric specified for outdoor products will typically come with a manufacturer warranty. SIXINCH, as with any other textile or leather, will not be liable for any outdoor rated material. Please refer to the manufacturer's website for their specific warranty.

Graded-In Fabrics or COM/COL Selections and Approvals

- SIXINCH works with hundreds of fabric choices a designer may want to specify for upholstered product. We offer fabric grading prices interspersed throughout this price list to assist pricing efforts for these many fabric choices. In addition to COM or COL services, SIXINCH will purchase graded-in materials for upholstery to a customer's written specifications and produce completed pieces at the prices noted.
- SIXINCH has not pre-evaluated all potential fabrics available to designers today for application on SIXINCH furniture styles. Graded-In selections must be approved by SIXINCH prior to processing of purchase orders. A memo sample must be submitted to SIXINCH for preliminary approval of ALL FABRICS or LEATHERS (with the exception of felt or crepe). Final approval of fabric / textile requires (1) linear yard to be provided for full evaluation. Once the Graded-In sample has been reviewed by the SIXINCH fabric management team a written response (email) to the customer will confirm the results of the evaluation. An explanation will be provided in the event a fabric selection is not approved. Refer to the SIXINCH Graded-In Fabric Program document for a list of Graded-In suppliers and material selections.

The customer is solely responsible for advising SIXINCH as to the direction of any patterned upholstery materials. Below are diagrams that provide help in determining application direction. Customer must submit application direction and information as to which is top and bottom on the purchase order or the COM will be applied based on SIXINCH common practices.

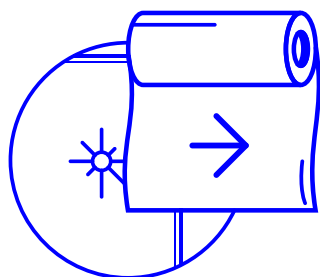

RAILROADED

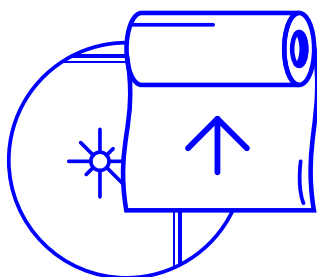

NON-RAILROADED

Pricing for Upholstered Furniture Ordered in Quantity

- Furniture ordered in higher quantities may qualify for lower prices based on better material utilization. This can be particularly true for orders involving SIXINCH Felt or Crepe. Contact SIXINCH Customer Service to understand how furniture order quantities may affect pricing. SIXINCH Customer Service will confirm material quantity requirements upon placement of your purchase order or upon your request for an upcoming order.

Special Fabric Backing or Finish Augmentation

- It is sometimes necessary to add a laminated backing or serging to fabrics to improve upholstery results. In these cases additional costs will be applied on a per yard basis. SIXINCH Customer Service will notify the customer of these requirements as well as pricing and lead time implications at the time a Graded-In or COM is evaluated.
- Every fabric specification is different. The specific characteristics of both fabrics and leather as well as furniture styles must be considered to achieve successful results. SIXINCH shall not be held responsible for incorrect specification of material. SIXINCH does not guarantee the performance, wear, durability or light fastness for any material included in this program except where covered by the warranty of the material provider on the specific fabric selection.

TECHNICAL DATA SHEET

FOAM

SIXINCH uses only the highest quality of polyurethane foam from the best suppliers in this field. All foams are produced in the United States. Foam type may vary by design.

STANDARD OFFERING

Density rating: 2.70 lb/ft
ILD rating: 65

FlexPlus™ Coating



UV Color Stability*

- SIXINCH UV pigments are color stable. Passing the 4 year climate test with the color red. Results: less glossy, no visible change in color.
- Atlas SUNTEST CPS+: Wavelength range 55
- 765 W/m, 10 cycles, 20 hour radiation test. Results: no change
- QUV Accelerated Weathering Tester: 4 days, UV radiation, humidity classification 0. Results: no change

Following has been tested on FlexPlus™

- Hand cream, Sunscreen Lotion – SPF 20, Lipstick – red 461, Foundation Creme – 108 honey beige, Olive oil.

***These products left no visible stains nor change in appearance when removed quickly.*



Weather & Water Resistance*

- Flex Plus™ coating is weather and water resistant
- Cold test: Thermotron SE-300-2-2, temperature at -40° C, for a duration of 24 hours. Results: no change in flexibility or description.
- Damp Heat cycle test: 80hr. 10 cycles, -40 °C to +85°C \with humidity 50% RH
- Dry Heat Test: BINDER incubator world test: +80°C, for a duration of 24 hours. Results: no change.



Ecology

- In some cases, SIXINCH products can be repaired and re-coated, which can extend the length of usage.
- The foam itself is 100% recyclable.
- SIXINCH is committed to recycling waste and uses the latest manufacturing technologies.
- Packaging is done to the highest standards using recycled and recyclable materials.



Maintenance & Cleaning

- Storage advice: In order to keep your SIXINCH furniture in peak condition, keep furniture inside and dry during extreme weather conditions.

- Normal cleaning: use warm water with a mild detergent and a cotton cloth.
- Stains: use Clorox Clean-UP to remove or reduce staining.
- Disinfecting: common agents for disinfection such as 409, Lysol, or a 1:10 bleach/ water solution may be used. Avoid using them in direct sunlight. Do not allow these products to stay on the surface for long. Spray on, wipe off and rinse residue off with clean water.

Remark: to avoid staining, immediately remove coffee, champagne, mayonnaise, red wine and other common stain agents.



Safety*

Flex Plus™ coating complies to the DIN EN71-3 standards for children's toys

Durability*

- Aging: BINDER incubator world test – coating description & flexibility
- Adhesion: Cross-cut tester ZCC 2080 – DIN / ISO 2409 n° T1079358
- Film Hardness Test: ISO 15184 Pencil Test – pass from 6B until 3B
- Scratch Test: hardness tester N° 5810 – pass from 1.00 N to 4.00 N (100 to 400 g)

* Based on European test results

TERMS & CONDITIONS

Please note that by placing any order with SIXINCH USA, PURCHASER agrees to be bound by these terms and conditions as set out below.

1. About this document:

1.1 This document sets out the terms and conditions ("the Conditions", these Conditions") of a SIXINCH USA ("SIXINCH") sale, purchased by a Dealer, A&D Firm, Purchasing Group, End User, Retail Customer, or any other entity ("PURCHASER")

1.2 SIXINCH may change these Conditions at any time. Those changes will not affect any orders already submitted by PURCHASER.

2. Definitions:

2.1 In these Conditions the following terms shall have the following meanings:

- Business Day: Monday to Friday, except bank or other public holidays
- Contract: the agreement formed when SIXINCH agrees to provide Goods to PURCHASER at an agreed upon Price, and which includes these Conditions
- Delivery Address: the Delivery Address provided by PURCHASER to SIXINCH.
- Goods: the Goods ordered by PURCHASER
- Price: the price of the Goods as notified by SIXINCH and then agrees to provide the Goods to PURCHASER
- SIXINCH: SIXINCH USA, a company registered in the United States, with primary contact phone number: 574 538 2417
- PURCHASER: any person or entity who orders Goods from SIXINCH USA

3. Application:

3.1 These Conditions apply to all orders placed by PURCHASER unless alternative terms are specifically written and agreed upon. No other terms or conditions shall apply.

4. Pricing:

4.1 All price lists, brochures and catalogs are intended as a guide only, and the price of all Goods shall be subject to confirmation by SIXINCH when PURCHASER places an order. Any offer SIXINCH makes to provide Goods at a certain Price shall only remain open for 14 days unless otherwise indicated on a SIXINCH quotation. After that period, the SIXINCH Offer shall be withdrawn.

4.2 Quotes for Canada and Mexico are issued in U.S. currency and valid for 30 calendar days. Freight can be quoted to the port of exit if required. All broker, customs, and freight within Canada and Mexico are not included in a SIXINCH quote.

5. Offers:

5.1 The Contract for provision of Goods between PURCHASER and SIXINCH shall be formed when SIXINCH notifies PURCHASER of the Price of the Goods and Conditions herein ("Offer"), and the PURCHASER wishes to proceed in ordering the Goods.

6. Delivery:

6.1 All delivery costs shall be paid by PURCHASER unless SIXINCH agree otherwise in writing.

6.2 Delivery shall be to the Delivery Address provided by PURCHASER in the order. No order will be acknowledged or processes without a confirmed Delivery Address.

6.3 SIXINCH does not accept liability for any damage to the Goods which occurs while in transit. All risk in the Goods shall pass to PURCHASER when the Goods leave the SIXINCH warehouse.

6.4 All delivery times are approximate and may be subject to change. Any delay in delivery shall not give PURCHASER the right to withhold payment, to refuse the receipt of the Goods, to receive any penalty reimbursement, or to terminate the Contract.

6.5 It is PURCHASER's responsibility to ensure that there is safe adequate access to the Delivery Address for the Goods PURCHASER has ordered, taking into account the size, weight and bulk of the Goods PURCHASER has ordered. If the Goods ordered cannot be off-loaded due to inadequate access, the Goods may be returned to the freight warehouse, and additional freight warehousing fees and additional re-delivery fees may apply.

6.6 It is PURCHASER's responsibility to ensure that PURCHASER has measured the area into which the Goods will be installed (as well as all areas of access to the installation area) correctly to ensure there is adequate access taking into account the size, weight and bulk of the Goods PURCHASER has ordered.

6.7 If PURCHASER is not present to collect the Goods or PURCHASER unreasonably refuses to take delivery of the Goods, SIXINCH may charge PURCHASER reasonable costs of returning the Goods to the freight depot, reasonable costs of storage, and reasonable charges for redelivering the Goods to PURCHASER. Under no circumstances does the refusal of a shipment constitute the cancellation of an order or the claim to recover or deny payment for the order.

6.8 Deliveries going into Canada or Mexico may require PURCHASER to provide PURCHASER's Broker information and Delivery Address with PURCHASER's purchase order. SIXINCH will quote estimated freight based on the port of exit/entry provided by PURCHASER. SIXINCH will not provide a freight estimate to the final destination in Canada or Mexico. PURCHASER's Broker will need to provide PURCHASER with a freight quote from port to the PURCHASER's final destination.

6.9 NAFTA Certificate of Origin Form will be completed by SIXINCH for each shipment going into Canada or Mexico.

7. Force majeure:

7.1 While SIXINCH endeavors to complete all orders within quoted lead times, certain circumstances beyond SIXINCH control may prevent this. These circumstances include natural disasters such as fire, floods, violent storms, service interrupting labor disputes, exclusions, transport difficulties, machine failure, default of suppliers, failure of suppliers to provide goods or components or similar uncontrolled difficulties. If such circumstances arise, SIXINCH shall have the right and be afforded time to (i) seek alternative arrangements with Purchaser, (ii) no longer provide the Goods and to provide PURCHASER with a full refund, or (iii) to provide the Goods only once the relevant circumstances permit.

8. Payment terms:

8.1 PURCHASER agrees to pay the Price, delivery charges and any other charges agreed.

8.2 Unless agreed to otherwise, payment terms for the Goods shall be 50% of the Price paid in advance at the time of the order and the balance of payment due prior to ship date. The production of the order will not commence until the first 50% deposit payment is received. If both parties agree to special product lead times of 4 weeks or less, full payment is due immediately upon order.

8.3 Any terms other than the terms noted in 8.2 here require an approved credit application by SIXINCH.

8.4 All invoices are payable at the SIXINCH registered office and / or via the bank account as stated in the invoice. In the event of non-payment by the due date, SIXINCH shall be entitled (i) to receive from PURCHASER interest of 1% per month on all outstanding amounts (ii) to receive from PURCHASER a further amount of 10 % of all outstanding amounts or \$100 (whichever is greater); and/or (iii) to suspend and/or terminate without notice all agreements with PURCHASER (including this Contract) without compensation or return of any amounts paid under such agreements.

8.5 Visa and MasterCard accepted with a 3.75% processing fee.

8.6 All payments are to be made in U.S. funds.

9. Defects and Complaints:

9.1 PURCHASER must immediately inspect the Goods on arrival at the Delivery Address.

WARRANTY

SIXINCH FLEXPLUS™ COATING

Many of the products in the SIXINCH Collection are created via a unique foam coating process which is incredibly durable, yet subject to many of the same criteria and constraints as other products coated or covered with vinyl, leather, fabric and like wearable finishes. The SIXINCH warranty applies to the original purchaser within North America from the date of purchase. SIXINCH will repair, replace, or prorate, at our sole discretion, any product deemed defective by SIXINCH within the warranty timelines listed and when used in the conditions for which they were designed. SIXINCH products are designed for use as seating and/or table purposes only.

FOAM TOLERANCES CAN VARY!

When placing your order, please ensure tolerances listed below fit into specified space.

0" to 2" = +/- 1/16"

2" to 36" = +/- 1/8"

36" or more = +/- 1/4"

Angles +/- 1°

FlexPlus™ coated surfaces shall be free of defects in materials and workmanship for a period of three (3) years. FlexPlus coated products intended to be used in non-standard furniture applications (i.e. stood on, walked on, or in "heavy use") shall be free of defects in material and workmanship for a period of one (1) year. FlexPlus coated products intended to be used in applications other than furniture uses (i.e. as "toys", building blocks, or without a wood base/glides) will not be covered under warranty.

Softening and creasing will occur through normal use and is not a manufacturing defect. SIXINCH foam coated products will naturally have minor variations in the top coated finish, as it is a handcrafted material. These variations do not detract from the overall appearance and are to be expected. Please refer to finish samples to better understand the "hand" this process creates. Coated surfaces can exhibit small aberrations in the paint surface over time including spot staining and/or slight cracking depending on depth and frequency of compression. FlexPlus coated products are subject to changes in surface sheen and may also be stainable under certain conditions such as outdoor applications where no regular cleaning is performed. During this (3) year period, SIXINCH will repair or replace free of charge, such products that prove to be defective. Labor and freight charges are not included for warranty related work.

SIXINCH UPHOLSTERY

SIXINCH warrants that indoor upholstery applications shall be free from defects in materials and workmanship for a period of five (5) years, while outdoor upholstery applications shall be free from defects in materials and workmanship for a period of three (3) years, all from the date of purchase. Softening of foam will occur through normal use and is not a manufacturing defect.

INDOOR UPHOLSTERED PRODUCTS (5) YEAR LIMITED WARRANTY

SIXINCH guarantees upholstered products only to be free from defects and that the upholstery is tailored according to product specifications. SIXINCH offers no warranty, either implied or expressed, on any fabrics, vinyls (indoor/outdoor), or leathers. Fabrics and leathers carry warranties from the fabric manufacturer or reseller, and most contract fabrics and leathers have only a one to two year warranty period. Please refer to each resellers warranties before specifying. Because every fabric specification is different and application for use must be taken into consideration, SIXINCH shall not be held responsible in any manner

for wrong specification of material (fabric, vinyl, leather), and SIXINCH does not guarantee specified material for tailoring, wear, durability, or light fastness. SIXINCH makes no warranty of any kind with respect to "customer's own materials" (COM), "customer's own leathers" (COL), or non-standard materials selected by and used at the request of the purchaser. During this (5) year period, SIXINCH will repair, replace, or prorate, at our sole discretion, any product deemed defective by SIXINCH within the warranty timelines listed and when used in the conditions for which they were designed. Labor and freight charges are not included for warranty related work.

OUTDOOR UPHOLSTERED PRODUCTS (3) YEAR LIMITED WARRANTY

SIXINCH upholstered products designated for outdoor use is warranted under the same terms as the indoor products, to the original customer, to be free from defects in materials and workmanship for a period of three (3) years. During this (3) year period, SIXINCH will repair, replace, or prorate, at our sole discretion, any product deemed defective by SIXINCH within the warranty timelines listed and when used in the conditions for which they were designed. Labor and freight charges are not included for warranty related work.

In addition to the limitations described above for indoor products, this warranty for outdoor products does not apply to damage or defects resulting from exposure to outdoor conditions such as high winds, heat, cold or humidity.

This outdoor products warranty is limited to products used in standard work environments.

We recommend storing cleaned, dry furniture under cover or covering it when not in use to protect it from debris and inclement weather. With proper care and maintenance, the product will maintain its structural integrity, and:

- Powder coated MDF surfaces should resist fading and cracking
- Powder coated metal finishes should resist fading and cracking
- Steel may develop small rust spots over time in places where damage has occurred, such as chipping, scratches or abrasions

This warranty does not cover those parts of the product which are exposed to abrasion during use.

SIXINCH WOOD, STEEL, ALUMINUM AND PLASTIC COMPONENTS (STRUCTURAL & EXPOSED)

SIXINCH warrants all wood, steel, aluminum and plastic elements, including structural frames, tables, storage units and decorative accents to be free of defects in material and workmanship for a period of three (3) years from date of purchase. This warranty does not extend to color, grain, or texture of natural materials, such as wood, marble or leather, or other natural variations over which SIXINCH has no control. SIXINCH does not warrant matching of color grain or texture.

SIXINCH ELECTRIC / ELECTRONIC COMPONENTS

SIXINCH warrants all electric and/or electronic components to be free of defects in material and workmanship for a period of one hundred eighty (180) days from date of purchase.

WARRANTY

LIMITATIONS AND EXCLUSIONS

This warranty excludes characteristics of normal wear, including the normal wear or aging of fabrics, finishes, paint, powder coating, spray coatings, foam and filler materials, issues of cleanliness, and the natural variations in grain, color, or texture of wood components. Normal wear in an outdoor setting will also be subject to temperature fluctuations outside of “livable norms”, and fading of applied materials due to exposure to daylight is to be expected.

Whenever a special material finish is requested, SIXINCH will attempt to match buyer’s special finish requests (via signed sample method) but assumes no responsibility if the approved sample does not meet the end user requirement.

Custom products (also known as Specials) convey the same warranties to craftsmanship and materials as standard products. Custom products require signed customer approval of relevant design drawings / documentation. SIXINCH does not warrant any customer approved custom product’s fit or usability or if the approved product (via signed drawings / documentation) does not meet the end user requirement. SIXINCH conveys no warranty for any customer specified material component such as fabrics, customer directed wood components, special upholstery materials or treatments, or any other customer-specified component. SIXINCH will simply apply the special component elements as directed. They shall be free from defects in workmanship per the original warranty statement.

This warranty excludes damage or defects to any product caused by abuse, negligence, abnormal usage, freight, storage / warehousing, accidents, improper maintenance, lack of routine maintenance, alterations, tampering, and/or improper installation. Like leather, vinyl and textiles, SIXINCH foam coated products are subject to staining from materials such as wine, coffee, etc. SIXINCH Care and Maintenance guidelines should be followed. Any product that arrives in a damaged carton must be photographed prior to unpacking and noted on the freight bill as part of the claims process. Note that certain foam coated products purposely designed without air release valves may not be transported via air or other manner where severe changes in air pressure occur. These products will be identified accordingly on product packaging.

SIXINCH products are used at the sole risk of the purchaser and any individuals using purchaser’s services or products. SIXINCH assumes no liability for injury or damages resulting from normal use or abuse of SIXINCH products. SIXINCH assumes no liability for labor, freight, injury, consequential or incidental damages, including any lost direct or indirect income or profits incurred by the original purchaser that may result from a defective SIXINCH product.

Warranties not expressly stated herein, including without limitations any implied warranties of merchantability and fitness for purposes are excluded and disclaimed by SIXINCH. No employee or independent sales representative of SIXINCH is authorized to change these warranties in any SIXINCH product.

MANDATORY WARRANTY CLAIM PROCEDURES

To submit a product warranty claim for evaluation, please contact SIXINCH customer support by email: support@sixinch.us. You will be required to provide the date of purchase and photographs of the product failure in question. In certain circumstances, a representative acting on behalf of SIXINCH (e.g., an Independent Sales Representative, Furniture Dealer or SIXINCH associate) may make a site visit to review, document and assist in claim validation and resolution. For any warranty replacements, SIXINCH will pay for ground shipping only – you will be charged the difference between ground shipping and any expedited shipping requested by you. SIXINCH will make its best efforts to remedy warranty issues as quickly as possible, but cannot guarantee immediate availability of replacement parts or products.

SIXINCH products are used at the sole risk of the purchaser and any individuals using purchaser’s services or products. SIXINCH assumes no liability for injury or damages resulting from normal use or abuse of SIXINCH products.

SIXINCH assumes no liability for labor, freight, injury, consequential or incidental damages, including any lost direct or indirect income or profits incurred by the original purchaser that may result from a defective SIXINCH product.

Warranties not expressly stated herein, including without limitations any implied warranties of merchantability and fitness for purpose are excluded and disclaimed by SIXINCH.

This warranty is valid January 1st, 2024